

TOSHIBA

MULTIFUNCTIONAL DIGITAL SYSTEMS

Fax Guide

e-STUDIO2822AF

e-STUDIO2329A/2829A

(with GD-1380)

Preface

Thank you for purchasing Toshiba Multifunctional Digital Systems.

This Fax Guide describes how to use the fax functions, troubleshooting and its maintenance, etc.
Be sure to read this manual before using this equipment. Keep this manual handy and retain it for future reference.

Notice to Users

For the U.S.A. only

WARNING FCC Notice: Part 15

This equipment has been tested and found to comply with the limits for a Class A digital device, pursuant to Part 15 of the FCC Rules. These limits are designed to provide reasonable protection against harmful interference when the equipment is operated in a commercial environment. This equipment generates, uses, and can radiate radio frequency energy and, if not installed and used in accordance with this guide, may cause harmful interference to radio communications. Operation of this terminal in a residential area is likely to cause harmful interference in which case the user will be required to correct the interference at his/her own expense.

Warning: Changes or modification made to this equipment, not expressly approved by Toshiba Tec Corporation or parties authorized by Toshiba Tec Corporation could void the user's authority to operate the equipment.

WARNING FCC Notice: Part 68

This equipment complies with Part 68 of the FCC rules and the requirements adopted by the ACTA. On the rear cover of this equipment is a label that contains, among other information, a product identifier in the format US: AAAEQ##TXXXX. If requested, this number must be provided to the telephone company.

This device is equipped with a USOC RJ11C connector.

A plug and jack used to connect this equipment to the premises wiring and telephone network must comply with the applicable FCC Part 68 rules and requirements adopted by the ACTA. A compliant telephone cord and modular plug is provided with this product. It is designed to be connected to a compatible modular jack that is also compliant. See installation instructions for details.

The REN is used to determine the number of devices that may be connected to a telephone line. Excessive RENs on a telephone line may result in the devices not ringing in response to an incoming call. In most but not all areas, the sum of RENs should not exceed five (5.0). To be certain of the number of devices that may be connected to a line, as determined by the total RENs, contact the local telephone company. For products approved after July 23, 2001, the REN for this product is part of the product identifier that has the format US: AAAEQ##TXXXX. The digits represented by ## are the REN without a decimal point (e.g., 03 is a REN of 0.3). For earlier products, the REN is separately shown on the label.

If this equipment causes harm to the telephone network, the telephone company will notify you in advance that temporary discontinuance of service may be required. But if advance notice isn't practical, the telephone company will notify the customer as soon as possible. Also, you will be advised of your right to file a complaint with the FCC if you believe it is necessary.

The telephone company may make changes in its facilities, equipment, operations or procedures that could affect the operation of the equipment. If this happens the telephone company will provide advance notice in order for you to make necessary modifications to maintain uninterrupted service.

If trouble is experienced with this equipment, for repair or warranty information, please contact Toshiba America Business Solutions Electronic Imaging Division at 1-800-468-6744. If the equipment is causing harm to the telephone network, the telephone company may request that you disconnect the equipment until the problem is resolved.

Connection to party line service is subject to state tariffs. Contact the state public utility commission, public service commission or corporation commission for information.

If your home has specially wired alarm equipment connected to the telephone line, ensure the installation of this equipment does not disable your alarm equipment. If you have questions about what will disable alarm equipment, consult your telephone company or a qualified installer.

The Telephone Consumer Protection Act of 1991 makes it unlawful for any person to use a computer or other electronic device, including Fax machines, to send any message unless such message clearly contains in a margin at the top or bottom of each transmitted page or on the first page of the transmission, the date and time it is sent and an identification of the business or other entity, or other individual sending the message and the telephone number of the sending machine or such business, other entity, or individual. (The telephone number provided may not be a 900 number or any other number for which charges exceed local or long-distance transmission charges.)

In order to program this information into your Fax machine, you should complete the following steps: complete the setup procedures listed for station ID number and name. See  P.82 “Registering the Terminal ID”.

CAUTION — To reduce the risk of fire, use only No.26 AWG or larger telecommunication line cord.

IMPORTANT SAFETY INSTRUCTION

When using your telephone equipment, avoid using a telephone (other than a cordless type) during an electrical storm. There may be a remote risk of an electric shock from lightning.

SAVE THIS INSTRUCTION

Toshiba America Business Solutions, Inc.

25530 Commercentre Drive, Lake Forest, CA 92630

For Canada only

This product meets the applicable Innovation, Science and Economic Development Canada technical specifications.

The Ringer Equivalence Number of your facsimile is 0.2

The Ringer Equivalence Number (REN) indicates the maximum number of devices allowed to be connected to a telephone interface. The termination of an interface may consist of any combination of devices subject only to the requirement that the sum of the RENs of all the devices not exceed five.

CAUTION — To reduce the risk of fire, use only No.26 AWG or larger telecommunication line cord.

This Class A digital apparatus complies with Canadian ICES-003. (CAN ICES-3 (A))

Le présent produit est conforme aux spécifications techniques applicables d’Innovation, Sciences et Développement économique Canada.

L’indice d’équivalence de la sonnerie de ce matériel 0.2.

L’indice d’équivalence de la sonnerie (IES) sert à indiquer le nombre maximal de dispositifs qui peuvent être raccordés à une interface téléphonique. La terminaison d’une interface peut consister en une combinaison quelconque de dispositifs, à la seule condition que la somme des IES de tous les dispositifs n’excède pas cinq.

ATTENTION – Pour réduire les risques d’incendie, utiliser uniquement des conducteurs de télécommunications 26 AWG au de section supérieure.

Cet appareil numérique de la classe A est conforme à la norme NMB-003 du Canada. (CAN NMB-3 (A))

IMPORTANT SAFETY INSTRUCTION

When using your telephone equipment, avoid using a telephone (other than a cordless type) during an electrical storm. There may be a remote risk of an electric shock from lightning.

SAVE THIS INSTRUCTION

IMPORTANTE MESURE DE SÉCURITÉ

Pendant l’utilisation de matériel téléphonique, éviter d’utiliser le téléphone (sauf s’il s’agit d’un appareil sans fil) pendant un orage électrique. Ceci peut présenter un risque de choc électrique causé par la foudre.

CONSERVER CETTE INSTRUCTION

Toshiba Tec Canada Business Solutions Inc.

75 Tiverton Court, Markham, Ontario, L3R 4M8

For NEW ZEALAND only

The grant of a Telepermit for any item of terminal equipment indicates only that Telecom has accepted that the item complies with minimum conditions for connection to the network. It indicates no endorsement of the product by Telecom, nor does it provide any sort of warranty. Above all, it provides no assurance that any item will work correctly in all respects with another item of Telepermitted equipment of a different make or model, nor does it imply that any is compatible with all of Telecom's network services.

This equipment is not capable, under all operating conditions, of correct operation at the higher speeds for which it is designated. Telecom will accept no responsibility should difficulties arise in such circumstances.

This equipment should not be used any circumstances which may constitute a nuisance to other Telecom customers.

Not all telephones will respond to incoming ringing when connected to the extension socket.

This device is equipped with pulse dialling while the Telecom standard is DTMF tone dialling. There is no guarantee that Telecom lines will always continue to support pulse dialling.

Use of pulse dialling, when this equipment is connected to the same line as other equipment, may give rise to bell tinkle or noise and may also cause a false answer condition. Should such problems occur, the user should NOT contact the Telecom Faults Service.

This device is intended for Stand-alone connection and not in parallel with other telephone devices.

The call log incorporated in this equipment does not record all answered calls. The call log, therefore may not agree with the Telecom account which may include calls not shown on the log.

If a charge for local calls is unacceptable, the 'Dial' button should NOT be used for local calls. Only the 7-digits of the local number should be dialled from your telephone. DO NOT dial the area code digit or the '0' prefix.

Toshiba (Australia) Pty Limited

58 Lunn Avenue
Mt Wellington 1072
New Zealand
Phone: 64 9 570 8530

Before Reading This Manual

■ How to read this manual

□ Symbols in this manual

In this manual, some important items are described with the symbols shown below. Be sure to read these items before using this equipment.

 **WARNING** Indicates a potentially hazardous situation which, if not avoided, could result in death, serious injury, or serious damage, or fire in the equipment or surrounding objects.

 **CAUTION** Indicates a potentially hazardous situation which, if not avoided, may result in minor or moderate injury, partial damage to the equipment or surrounding objects, or loss of data.

 **Note** Indicates information to which you should pay attention when operating the equipment.

 **Tip** Describes handy information that is useful to know when operating the equipment.

 Pages describing items related to what you are currently doing. See these pages as required.

□ Model and series names in this manual

In this manual, each model name is replaced with the series name as shown below.

Model name	Series name in this manual
e-STUDIO2329A/2829A	e-STUDIO2829A Series

□ Explanation for control panel

- The details on the control panel may differ depending on the operating environment such as whether options are installed.
- The illustration screens used in this manual are for paper in the A/B format. If you use paper in the LT format, the display or the order of buttons in the illustrations may differ from that of your equipment.

□ Options

For the available options, refer to “Specifications of Options” in the *User’s Guide* for your equipment.

□ About the defaults shown in this manual

- The defaults shown in this manual are the values in the standard operating environment. The values may have been changed from these defaults. The defaults for your model may differ from the defaults shown.
- The default for the list item is shown underlined.

□ Screens and Operation Procedures

- In this manual, the screens and the operation procedures in Windows are described for Windows 10. The details on the screens may differ depending on how the equipment is used, such as the status of the installed options, the OS version and the applications.
- The illustration screens used in this manual are for paper in the A/B format. If you use paper in the LT format, the display or the order of buttons in the illustrations may differ from that of your equipment.

❑ Description of original/paper direction

Paper or originals of A4, B5 or LT size can be placed either in a portrait direction or in a landscape direction. In this manual, “-R” is added to this paper size when this size of paper or original is placed in a landscape direction.

Example: A4 size original on the original glass

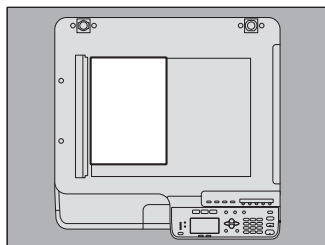

Placed in a portrait direction: A4

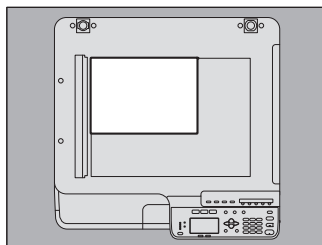

Placed in a landscape direction: A4-R

Paper or originals of A3, B4, LD or LG can only be placed in a landscape direction, therefore “-R” is not added to these sizes.

❑ Trademarks

For trademarks, refer to the **Safety Information**.

■ Lineup of our manuals

These manuals are provided for the operation of the e-STUDIO2822AF or e-STUDIO2829A Series. Select and read the manual best suited to your needs. This manual is the **Fax Guide**.

Safety Information (Printouts)

This manual describes the necessary precautions for use. For your added security, be sure to read this manual first.

Quick Guide (Printouts)

This manual describes the components, preparations, basic operations, and troubleshooting for the equipment.

User's Guide (PDF file)

This manual describes preparations for using the e-STUDIO2822AF or e-STUDIO2829A Series, and how to use functions such as copying, printing, and scanning. It also describes maintenance and troubleshooting for the problems that could occur while you are using the equipment.

Software Installation Guide (PDF file)

This manual describes how to install and uninstall printer and scanner drivers.

TopAccess Guide (PDF file)

This manual describes how to use the co-packed utility “TopAccess”. The settings and management of the equipment can be done using a Web browser.

Fax Guide (PDF file, this manual)

This manual describes how to use the Fax functions. Various functions both basic and advanced regarding Fax transmission/reception are available.

Help menu for client software

To run the following client software, refer to the Help menu of each:

- Printer driver
- Scan driver
- N/W-Fax driver
- e-STUDIO Scan Editor

❑ To read manuals in the PDF file format

This manual in the PDF (Portable Document Format) can be displayed/printed using Adobe Acrobat Reader. If it is not installed in your computer, download it via the website of Adobe Systems.

■ Singapore Portion

Complies with
IDA Standards
DA101747

General Precautions

■ Disclaimer notice

The following notice sets out the exclusions and limitations of liability of TOSHIBA TEC CORPORATION (including its employees, agents and sub-contractors) to any purchaser or user (hereafter "User") of the e-STUDIO2822AF or e-STUDIO2329A/2829A, including its accessories, options and bundled software (hereafter "Product").

1. The exclusion and limitations of liability referred to in this notice shall be effective to the fullest extent permissible at law. For the avoidance of doubt, nothing in this notice shall be taken to exclude or limit TOSHIBA TEC CORPORATION's liability for death or personal injury caused by TOSHIBA TEC CORPORATION's negligence or TOSHIBA TEC CORPORATION's fraudulent misrepresentation.
2. All warranties, conditions and other terms implied by law are, to the fullest extent permitted by law, excluded and no such implied warranties are given or apply in relation to the Products.
3. TOSHIBA TEC CORPORATION shall not be liable for any loss, cost, expense, claim or damage whatsoever caused by any of the following:
 - use of handling of the Product otherwise than in accordance with the manuals, including but not limited to the Fax Guide, and/or incorrect or careless handling or use of the Product;
 - any cause which prevents the Product from operating or functioning correctly which arises from or is attributable to either acts, omissions, events or accidents beyond the reasonable control of TOSHIBA TEC CORPORATION including without limitation acts of God, war, riot, civil commotion, malicious or deliberate damage, fire, flood, or storm, natural calamity, earthquakes, abnormal voltage or other disasters;
 - additions, modifications, disassembly, transportation, or repairs by any person other than service technicians authorized by TOSHIBA TEC CORPORATION; or
 - use of paper, supplies or parts other than those recommended by TOSHIBA TEC CORPORATION.
4. Subject to paragraph 1, TOSHIBA TEC CORPORATION shall not be liable to Customer for:
 - loss of profits, loss of sales or turnover; loss of or damage to reputation; loss of production; loss of anticipated savings; loss of goodwill or business opportunities; loss of customers; loss of, or loss of use of, any software or data; loss under or in relation to any contract; or
 - any special, incidental, consequential or indirect loss or damage, costs, expenses, financial loss or claims for consequential compensation;

whatsoever and howsoever caused which arise out of or in connection with the Product or the use of handling of the Product even if TOSHIBA TEC CORPORATION is advised of the possibility of such damages. TOSHIBA TEC CORPORATION shall not be liable for any loss, cost, expense, claim or damage caused by any inability to use (including, but not limited to failure, malfunction, hang-up, virus infection or other problems) which arises from use of the Product with hardware, goods or software which TOSHIBA TEC CORPORATION has not directly or indirectly supplied.

CONTENTS

Preface	3
Notice to Users	4
Before Reading This Manual	7
General Precautions	10
<hr/> Chapter 1 BEFORE USING FAX <hr/>	
Description of Each Component	14
Control panel	14
Fax screen.....	16
Connecting Cables	17
<hr/> Chapter 2 SENDING A FAX <hr/>	
Basic Procedures	20
Sending a Fax after calling the recipient	22
Setting an original.....	23
Setting the transmission conditions.....	26
Specifying the recipient.....	28
Checking and Canceling the Transmissions	34
Checking Transmission Status (log).....	34
Checking and canceling the reserved transmissions.....	34
Canceling transmission when an original is being scanned	35
<hr/> Chapter 3 RECEIVING A FAX <hr/>	
Reception Mode	38
AUTO reception	38
Memory reception.....	38
Manual reception	38
Remote reception	39
Forwarding received faxes	39
Checking reception status (log)	39
Originals and Paper	40
Acceptable size of paper.....	40
Default setting for RX printing.....	40
Paper priority when there is no same size paper	40
Setting a Fax drawer	42
Printing SECURE RECEIVE Fax Jobs	44
<hr/> Chapter 4 PRINTING LISTS AND REPORTS <hr/>	
Printing Lists & Reports Manually	46
Journal (transmission and reception journal)	46
Reservation list.....	47
Dial list	47
Printing Lists & Reports Automatically	49
List/Report Samples	50
Activity Report (transmission and reception journal).....	50
Memory Data List (reservation list)	50
TX Result Report (memory transmission report)	51
Dial list.....	51

Chapter 5 SENDING A N/W-FAX

Features and Functions	54
Features.....	54
Functions	54
Faxing from Applications	55
How to fax using the N/W-Fax driver.....	55
Specifying recipients	57
Setting up the network fax options.....	59
Sending with extended fax functionality.....	62
Managing Address Book	65
Opening and creating the address book	65
Managing contacts and groups.....	66

Chapter 6 SETTING ITEMS

Operating the USER FUNCTIONS Menu	74
Character Entry.....	75
Switching the input mode	75
Entering characters.....	75
Relationship between the digital keys and the input character	76
User Functions Menu Items	77
User functions menu items	77
FAX	78
REPORT SETTING	81
LIST	81
ADDRESS BOOK.....	81
Registering the Terminal ID.....	82
Managing the Address Book	84
Registering or modifying a Speed Dial number	84
Registering or modifying a Group Dial number.....	86
Registering or modifying a One Touch Dial key number	88
Setting SECURE RECEIVE.....	90

Chapter 7 TROUBLESHOOTING AND SPECIFICATIONS

Troubleshooting	92
Error messages.....	92
Transmission/reception trouble	93
Specifications of Fax.....	95
INDEX	97

1

BEFORE USING FAX

This chapter describes the basics of this equipment you should know before you start using it.

Description of Each Component	14
Control panel	14
Fax screen.....	16
Connecting Cables	17

Description of Each Component

Control panel

This section describes the buttons on the control panel used for the fax functions. For any details of the control panel not covered in this document, refer to the *User's Guide*.

e-STUDIO2822AF

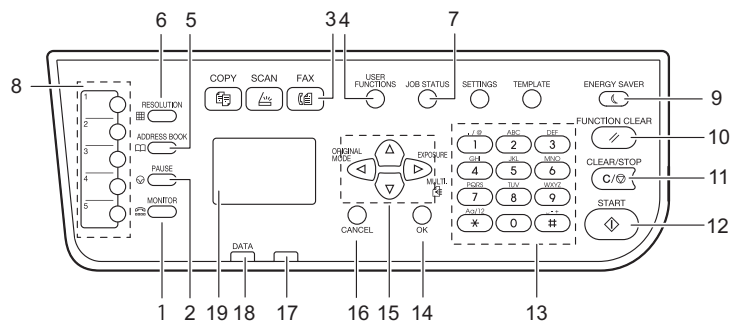

e-STUDIO2829A Series

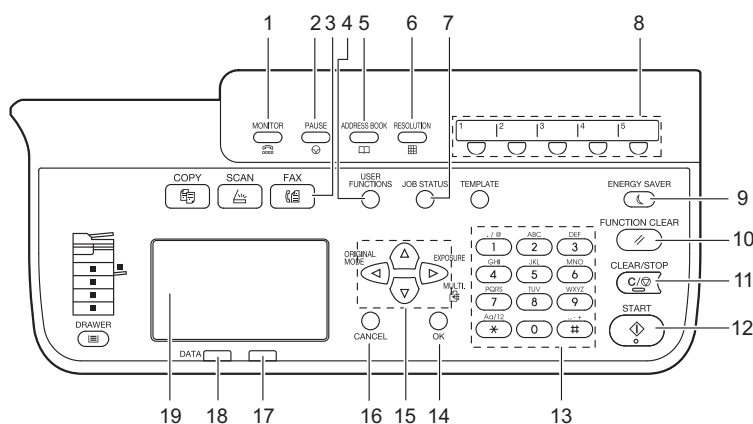

- 1. [MONITOR] button**
Use this button to dial the number without picking up the handset of the external telephone.
- 2. [PAUSE] button**
Use this button to inset a pause (of approximately 2 seconds) during direct entry.
- 3. [FAX] button**
Use this button to display the fax screen to use the fax function.
This lamp blinks when a fax is received using the SECURE RECEIVE function.
- 4. [USER FUNCTIONS] button**
Use this button when you register/make settings such as initial setting for the fax function.
- 5. [ADDRESS BOOK] button**
Use this button to display the Address Book screen and specify the recipient.
- 6. [RESOLUTION] button**
Use this button to change the scanning resolution.
- 7. [JOB STATUS] button**
Use this button to view the job status or its history.

8. One Touch Dial keys

Use a key as a one touch key to specify a recipient when sending a Fax document.

9. [ENERGY SAVER] button

Use this button when not using the equipment for a while. The equipment enters into the Energy Save mode, turning off the LCD screen as well as the other lamps. Receiving a Fax document or pressing [ENERGY SAVER], [START], [COPY], [SCAN], or [FAX] cancels the Energy Save mode.

10. [FUNCTION CLEAR] button

Use this button to clear all current selected functions and operations, and return to the default settings.

Tip

Even if the [FUNCTION CLEAR] button is not pressed, the function settings are automatically returned to the default ones and the initial screen is displayed when the auto clear setting time has passed after the completion of FAX transmission/reception or the last press of a button. If the department management function is performed, the department code entry screen is displayed. For details, see the *User's Guide*.

11. [CLEAR/STOP] button

Press this button to clear the values entered using the digital keys, or to abort scanning of documents.

12. [START] button

Use this button to start scanning a document for fax transmission.

13. Digital keys

Use these keys to enter fax numbers, etc.

14. [OK] button

Use this button to determine items or operation selected in each menu.

15. Δ / ∇ / \triangleleft / \triangleright (UP/DOWN/LEFT/RIGHT) buttons

Use them to select items you want to set in each menu. The selected item is highlighted. Moreover, the \triangleright button (the [MULTI] button) is used to create a manual grouping for multi-address transmission.

16. [CANCEL] button

Use this to cancel the current setting and return to the previous menu.

17. Alarm lamp

This lamp lights when an error occurs and this equipment needs some actions to be taken.

18. PRINT DATA lamp

This lamp blinks when fax is being transmitted/received or network fax data from a computer are being received.

19. LCD screen

Displays error messages in addition to various menus.

■ Fax screen

When you press the [FAX] button on the control panel, the screen shown below is displayed.

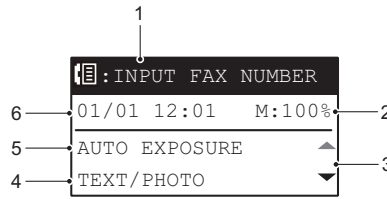

- 1. Message**
Displays the current status or error messages.
- 2. Remaining memory**
Display the percentage of remaining memory.
- 3. Scroll icon**
Displays the \triangle or ∇ button that you can press on the current screen or menu.
- 4. Original mode**
Displays the original mode.
- 5. Exposure**
Displays the exposure settings.
- 6. Current date and time**
Displays the current date and time.

Tip

When the department management function is performed in this equipment, the department code entry screen is displayed after the power is turned ON. Enter the department code (5-digit) in it using the digital keys and press the [OK] button to switch the screen.

DEPARTMENT CODE
—
: 12

Connecting Cables

Be sure that the power of this equipment is turned OFF before connecting the cables.

e-STUDIO2822AF

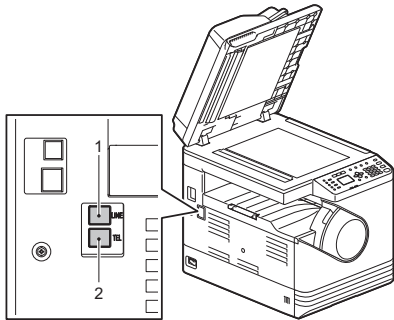

e-STUDIO2829A Series

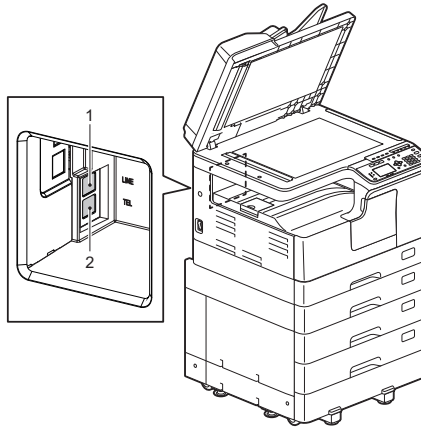

- 1. LINE**
Connect a telephone line.
- 2. TEL**
Connect an external telephone.

Note

- Do not connect this equipment and the external telephone to a telephone outlet in parallel.
- When connecting an external telephone to TEL, use one without an answerphone (or with the function turned off).

SENDING A FAX

This chapter describes how to send a fax.

Basic Procedures	20
Sending a Fax after calling the recipient	22
Setting an original.....	23
Setting the transmission conditions.....	26
Specifying the recipient.....	28
Checking and Canceling the Transmissions	34
Checking Transmission Status (log).....	34
Checking and canceling the reserved transmissions.....	34
Canceling transmission when an original is being scanned	35

Basic Procedures

This section describes the basic procedure to send a fax. For details of each operation, see the page indicated in the procedure as required.

1 Place the original(s).

e-STUDIO2822AF

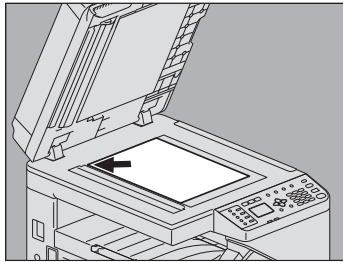

e-STUDIO2829A Series

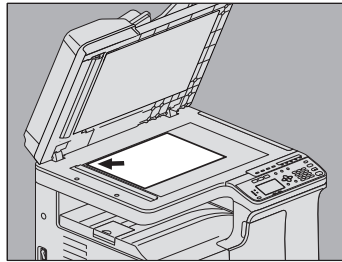

Check the original size and scanning range, etc. Place the original(s) on the original glass or RADF (Reversing Automatic Document Feeder) in the correct direction. (The illustration above shows the original placed on the original glass.)

 P.23 “Setting an original”

2 Press [FAX].

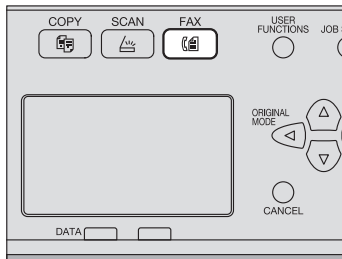

When the department management function is not performed, the fax screen is displayed.

When the department management function is performed, the following screen is displayed. Enter the department code (5-digit) in it using the digital keys and press the [OK] button. To correct the values entered, press the [CLEAR/STOP] button.

DEPARTMENT CODE
—
 : 12

Tip

For details on the department management function, see the **User's Guide**.

In addition, if you leave the equipment unattended for the period of the auto clear setting time (45 sec. by manufacturer default), the screen automatically returns to the initial one when department management is not performed, and returns to the department code entry screen when department management is performed.

3 Set the transmission conditions as required.

 : INPUT FAX NUMBER
01/01 12:01 M:100%
AUTO EXPOSURE ▲
TEXT/PHOTO ▼

Set the transmission conditions such as resolution, original mode and exposure, as required.

 P.26 “Setting the transmission conditions”

4 Specify the recipient.



P.28 “Specifying the recipient”

5 Press [START].

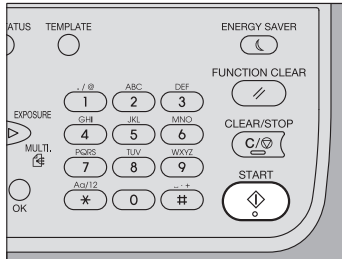

The originals are scanned and the fax, reserved.

- If memory becomes full during scanning in the memory transmission mode, that original will not be stored in memory. When that happens, reduce the number of originals you are sending.
- You can check the status of the current transmission. You can also cancel the transmission (delete the job).
 P.34 “Checking and Canceling the Transmissions”

Redial function

In the transmission mode, if the fax cannot be sent due to a busy-line, the fax number is redialed automatically to send the fax. If you want to change the number of times the equipment will redial, contact your service technician.

Sending the next original

If an original is placed on the original glass and its scanning is completed, the confirmation screen for the next original is displayed. To continue scanning the next original, set the original, select [SCAN NEXT PAGE], and then press [OK]. Once all originals have been scanned, select [FINISHED] with ∇ , and then press [OK].



- If you leave the screen unattended for the set auto clear time (45 sec. by manufacturer default), a copy of the scanned originals is sent.
- To cancel the transmission, press [CLEAR/STOP].
 P.35 “Canceling transmission when an original is being scanned”

■ Sending a Fax after calling the recipient

This section describes how to send a fax after you have called the recipient using the external telephone and confirmed that there is someone there.

Tip

- Connect the external telephone to the TEL terminal.
- Set [OFF] in [DOUBLE CHECK] of the USER FUNCTIONS menu beforehand.
📖 P.78 “FAX”
- Instead of picking up the handset of the external telephone, by pressing the [MONITOR] button with the following procedure, you can carry out the same operation.
- When a fax job transmission is performed by using an external telephone, it is transmitted with the vertical direction width of the original set on the RADF.

When an A4-size original is set on the RADF in a landscape direction, a job is transmitted in A4-size data. However, when an A4-size original is set on the RADF in a portrait direction, a job is transmitted in A3-size data. Therefore, if the recipient’s fax machine does not support A3-size printing, the transmitted data will be reduced to a paper size which can be printed by the machine.

1 As for normal fax transmission, place the original, press [FAX] to switch to the fax screen and set the transmission conditions.

📖 P.20 “Basic Procedures”

2 Pick up the handset of the external telephone.

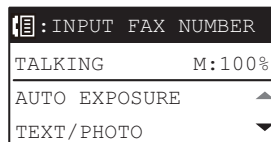

3 Enter the fax number.

You can specify the recipient using the One Touch Dial, Speed Dial or Search function.

Tip

The number cannot be deleted once it is entered. So if you press the wrong one, hang up the handset, pick it up again and then reenter it.

4 Press [START].

5 When an original is placed on the original glass, the following screen is displayed. Select [TX] and press [OK].

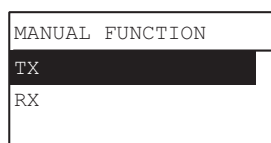

Tip

This screen does not appear if [EASY MANUAL TX/RX] is set to [EASY MODE].

📖 P.78 “FAX”

6 Put down the handset of the external telephone.

■ Setting an original

□ Setting an original on the original glass

This section describes how to set an original on the original glass. Originals are sent in the order they are placed on the original glass.

⚠ CAUTION

Do not place any heavy objects (4 kg/9 lb. or over) on the original glass and do not press on it with force. Breaking the glass could injure you.

1 Raise the Original Cover or RADF, and place the original with its face down on the glass.

e-STUDIO2822AF

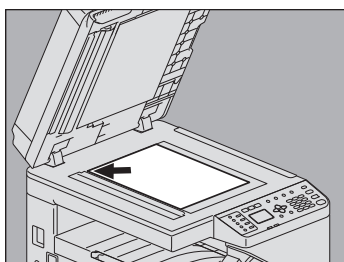

e-STUDIO2829A Series

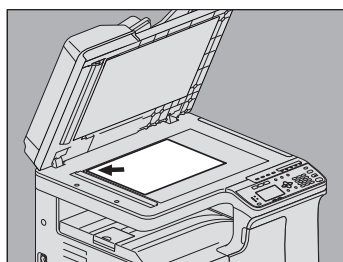

Raise it 60 degrees or more to detect the original size with AUTO SIZES function (this function is only available for e-STUDIO2829A Series).

2 Align the original against the left inner corner of the glass.

e-STUDIO2822AF

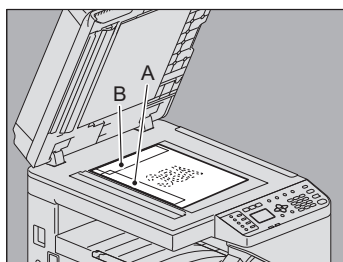
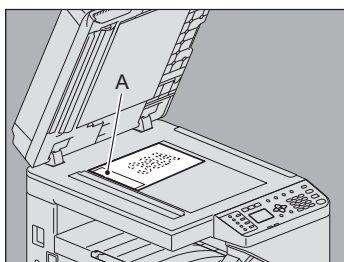

e-STUDIO2829A Series

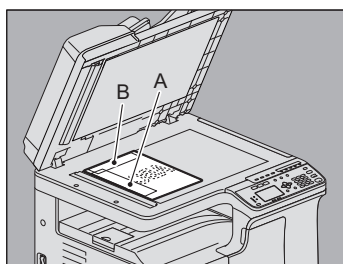
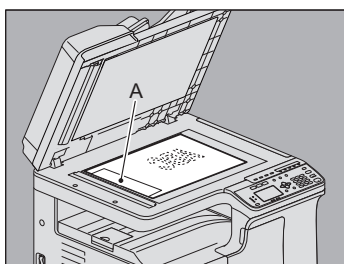

- Different size originals can also be sent in one transmission.
The original size is the size that you have set initially. When sending an original of a size larger than the set size, make sure that all contents are scanned and no portions are left out.
- When an original is placed in the direction shown in the figure on the left:
The original is transmitted so that the pre-entered sender information is printed in position A in the figure.
- When an original is placed in the direction shown in the figure on the right:
The original is transmitted so that the pre-entered sender information is printed in position B in the figure if the size of the original is LT/A4, and in position A in the figure if the size is other than LT/A4.
- The pre-entered sender information shows what is registered in the Terminal ID.
📖 P.82 "Registering the Terminal ID"

3 Lower the Original Cover or RADF slowly.

□ Setting originals on RADF

This section describes how to set originals on the RADF (Reversing Automatic Document Feeder). When the originals are placed on the RADF, the uppermost page is the first to be scanned and sent.

1 After aligning the originals, place them with their face up and slide the guides to rest against the edges of the originals.

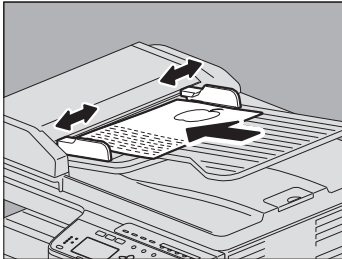

- Regardless of their sizes, originals are acceptable up to 50 sheets (50 to 104 g/m² (13.3 to 27.7 lb.)) or 9.5 mm (0.37") in height.
- 2-sided originals can be set and sent.
📖 P.27 "SINGLE/2-SIDED SCAN"

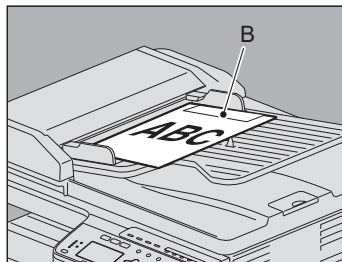
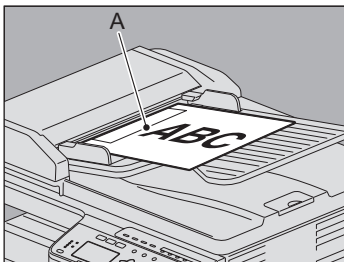

- When an original of any size other than LT/A4 is placed in the direction shown in the above left figure, transmission to a recipient is carried out so that the pre-entered sender information is printed in position A in the figure.
- When an original of LT/A4 size is placed in the direction shown in the above right figure, transmission to a recipient is carried out so that the pre-entered sender information is printed in position B in the figure.
- The pre-entered sender information shows what is registered in the Terminal ID.
📖 P.82 "Registering the Terminal ID"

Sending same width originals

The RADF allows for sending originals of mixed sizes but the same width. Available combinations of the original size are as follows.

- A/B format: A3/A4, B4/B5
- LT format: LD/LT, LG/LT-R

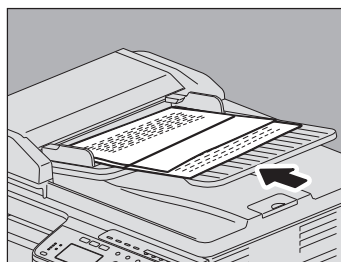

Tip

To send same width originals, you need to enable "MIXED SIZE ORIGINAL" as a transmission condition.

📖 P.26 "Setting the transmission conditions"

❑ Precautions for using the RADF

Do not use the following types of original as they may cause a paper misfeed or damage to the equipment:

- Originals that are folded or curled
- Originals with carbon copies
- Originals that have been taped, pasted, or cut-out
- Originals that have been clipped or stapled
- Originals with holes or tears
- Originals that are damp
- Originals whose correction fluid or ink has not been dried completely
- Overhead transparencies or tracing paper
- Coated paper (e.g. coated with wax)
- Originals with multiple holes punched (e.g. loose leaf paper)

The following types of originals can be used but need extra care:

- Originals that you cannot slide with your fingers or whose surface is specially treated: They should be fanned well before loading since they may not be able to be separated from each other at feeding.
- Originals that are folded or curled: They should be smoothed out before being loaded.

❑ Acceptable originals

This equipment can send a fax of the following originals.

You can place 1-sided or 2-sided originals of the media types, such as standard paper, recycled paper and paper with holes (2, 3 or 4 holes) for filing, on the RADF (Reversing Automatic Document Feeder). On the original glass, you can place 1-sided originals of the above media types as well as OHP film, tracing paper, booklets and three-dimensional objects.

Location	Maximum size	Paper weight	Maximum Number that Can be Set	Original size
Original glass	Length: 297 mm (11.69") Width: 432 mm (17.01")	-	-	A/B format: A3*, A4, A4-R*, A5-R, B4*, B5, B5-R*, FOLIO* LT format: LD*, LG*, LT, LT-R*, ST-R, COMP* K format: 8K*, 16K, 16K-R
RADF	Length: 297 mm (11.69") Width: 433.8 mm (17.08")	50 to 104 g/m ² (13.3 to 27.7 lb.)	50 sheets	A/B format: A3, A4, A4-R, A5-R, B4, B5, B5-R LT format: LD, LG, LT, LT-R, ST-R, COMP K format: 8K, 16K, 16K-R

* Only for e-STUDIO2829A Series

Note

- Up to 50 sheets (1-sided: 50 pages, 2-sided: 100 pages) using the RADF and up to 50 pages placed on the original glass can be sent in one fax transmission.
- Do not place any heavy objects (4 kg/9 lb. or over) on the original glass and do not press on it with force.
- If the original is any of the following sizes, it is automatically rotated and sent as described below.
A4 → A4-R
LT → LT-R

❑ Original scanning range

The following figures show the original scanning area. Any information in the shaded area is not printed on the paper.

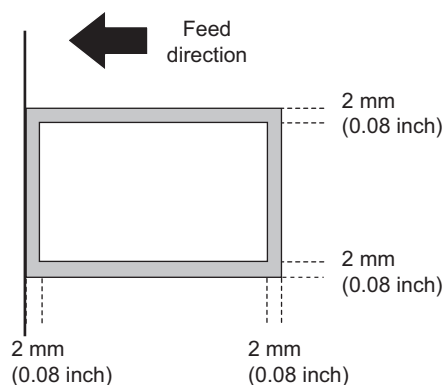

■ Setting the transmission conditions

You can set the fax transmission conditions.

Tip

- The transmission conditions are only applied to the current transmission. They return to the default settings after the transmission.
- Each default setting of resolution, original mode, exposure and ECM is adjustable.
📖 P.77 "User Functions Menu Items"

❑ Making settings

An example is explained below for [ORIGINAL MODE].

1 Press Δ or ∇ to highlight the item to set.

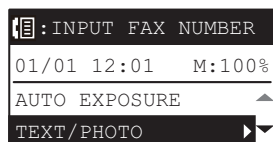

2 Press \triangleright to display the items in the lower hierarchies.

3 Press Δ or ∇ to select the value to set.



Repeat step 2 and 3 as many times as needed.

4 Press [OK] to confirm the set value.

❑ Settings

EXPOSURE

Set the density at which the original is to be scanned.

- AUTO: This equipment automatically detects the contrast of the original, and scans it with the optimum density.
- Manual: Press \triangleleft or \triangleright to set the desired contrast.

ORIGINAL MODE

Set the scanning mode based on the type of the original.

- TEXT: This is suitable for an original with text and line drawings.
- TEXT/PHOTO: This is suitable for an original with a mixture of text and photos.
- PHOTO: This is suitable for an original with photos.

Tip

In the TEXT/PHOTO mode or PHOTO mode, transmission time may be longer than that in the TEXT mode.

RESOLUTION

Set the resolution based on the fineness of the original.

- STANDARD: This is suitable for an original with regular size text.
- FINE: This is suitable for an original with small size text and fine illustrations.
- ULTRA FINE: This is suitable for an original with ultra-fine illustrations.

Tip

- The Resolution Settings screen can also be displayed by pressing [RESOLUTION].
- If the recipient's fax machine is not capable of receiving originals at the same resolution, the resolution is automatically converted before being sent to the recipient. The higher the resolution is, the longer it takes to send an original.

QUALITY TX

Switch Quality TX ON or OFF. When this mode is set to ON, originals are sent at a slower speed than usual and the chances of errors occurring decrease.

SINGLE/2-SIDED SCAN

You can send a copy of 2-sided originals by fax using the RADF (Reversing Automatic Document Feeder).

- SINGLE: This is suitable for 1-sided originals.
- DUPLEX: This is suitable for 2-sided originals.

When you place a 2-sided original of the LT/A4 size, change the direction of the original depending on its bind position as follows:

1. Right-to-left (book-type) original
2. Top-to-bottom (tablet-type) original

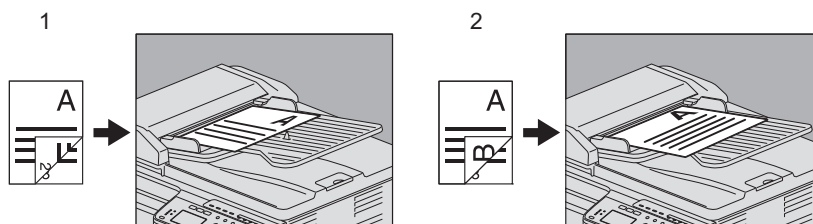

Tip

Note that each setting will automatically return to its default setting when transmission is completed.

ORIGINAL SIZE

Set the scan size of the original.

- AUTO SIZES: The size of the original is automatically determined before the original is scanned.
- Specified size: The original is scanned at the preset size regardless of its actual size.

* With e-STUDIO2829A Series, if the size of an original placed on the original glass cannot be determined, it is set to LD/A3.

Tip

If the recipient's fax machine is not capable of receiving originals of B5 size, this equipment may reduce that size before sending it. To avoid this, when the original to be set is B5 size, specify LT/A4 size respectively.

MIXED SIZE ORIGINAL

Switch Mixed Size Original ON or OFF. When this mode is set to ON, you can mix originals of different length. The size of the original is automatically determined before the original is scanned.

* This mode is only available for the equipment with the RADF installed.

Note

Originals of different width are not acceptable.

ECM

Switch the ECM (Error Correction Mode) communication ON or OFF. ECM is an internationally standardized communication mode that automatically corrects errors that occur during fax transmissions. With this setting option ON, even when the transmitted data have been affected by noise during communication, this mode allows good communication without image distortion by automatically resending the parts that have been affected.

Note

- Both the sender and the receiver must have the ECM function to make ECM communication available.
- When affected by noise during communication, communication time is slightly longer than usual. Even when the ECM communication is used, an error may occur depending on the line status.
- The ECM communication is not available for voice communication.

■ Specifying the recipient

There are various ways to specify the recipient, such as Direct entry with the control panel and Address Book entry.

Tip

To use the address book, you need to register recipients' fax numbers to the book in advance. For details of the operation, refer to the *User's Guide* or *TopAccess Guide*.

□ Direct entry with digital keys

You can specify the recipient by entering its fax number on the control panel.

1 Enter the fax number of the recipient using the digital keys.

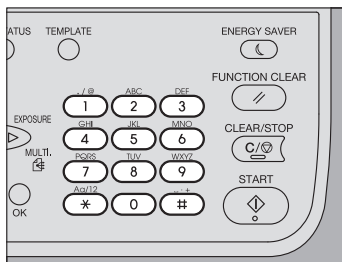

Normal transmission



Multi-address transmission

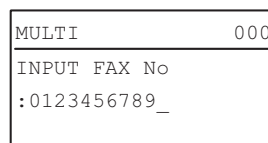

- Press [#] twice to enter a space.
- Press [CLEAR/STOP] to delete one digit of the entered number. Keep pressing [CLEAR/STOP] for a second to clear the number entirely.

Note

When you are dialing to an outside line via a PBX, there may be a pause before the connection is made, causing a transmission error. To avoid this error, press the [PAUSE] button after the number that designates an outside line to enter a pause.

This automatically enters a two-second pause before the recipient's fax number is dialed, which reduces transmission errors. (The mark “-” is displayed as a “pause” on the screen.)

2 Press [START].

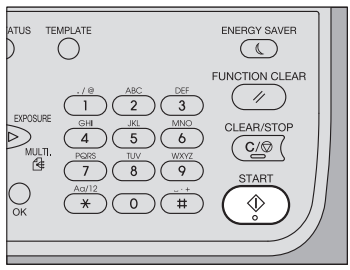

One Touch key dialing

You can register the telephone numbers beforehand in the One Touch Dial keys, and specify the recipient simply by pressing the keys.

- It is required to register the One Touch Dial keys beforehand.
[P.88 “Registering or modifying a One Touch Dial key number”](#)
- You can confirm the One Touch Dial keys already registered.
[P.52 “One Touch Dial key list”](#)

1 Press any one of the One Touch Dial keys (1 to 5).

e-STUDIO2822AF

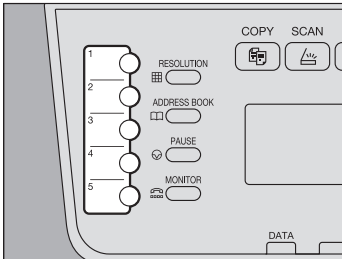

e-STUDIO2829A Series

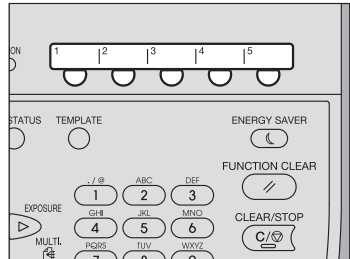

- Pressing multiple One Touch Dial keys consecutively sets as destination the key pressed last.
- To delete all the entered values at once, press [CLEAR/STOP].
- You can specify multiple recipients to send the same document at once. Be sure to press the One Touch Dial key after pressing [MULTI] each time you add a destination. You can also specify the recipients' fax numbers by combining with other entry methods. The number of recipients you can simultaneously specify is limited to 220.

Note

When you are dialing to an outside line via a PBX, there may be a pause before the connection is made, causing a transmission error. To avoid this error, press the [PAUSE] button after the number that designates an outside line to enter a pause.

This automatically enters a two-second pause before the recipient's fax number is dialed, which reduces transmission errors. (The mark “-” is displayed as a “pause” on the screen.)

2 Confirm the recipient, and then press [OK].



3 Press [START].



Multi-address transmission (Broadcasting)

You can specify multiple recipients to send the same document at once.

1 Press \triangleright (MULTI).

e-STUDIO2822AF

e-STUDIO2829A Series

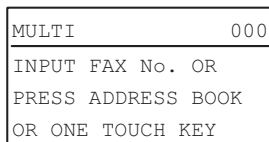
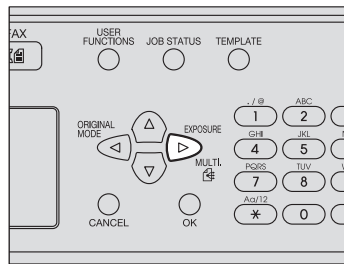
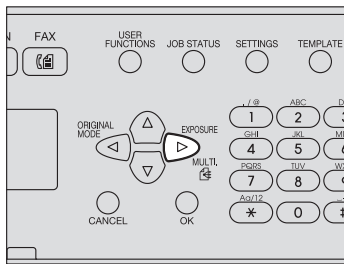

2 Specify the recipients.

- P.28 “Direct entry with digital keys”
- P.29 “One Touch key dialing”
- P.31 “Specifying the recipient from the address book”
- P.31 “Searching the recipient in the address book”

3 Press [OK].

4 To add a recipient, press \triangleright .

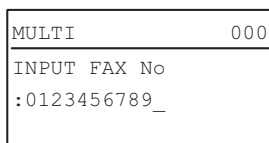

Repeat steps 2 through 4 until all the recipients are specified. The number of recipients you can simultaneously specify is limited to 220.

Tip

- Select [REVIEW LIST] and then press \triangleright to confirm/delete the specified recipients.

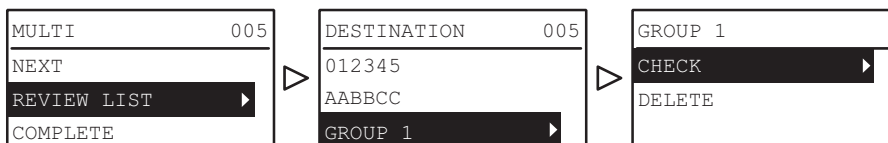

- Select [CHECK] and then press \triangleright to confirm the specified recipients.

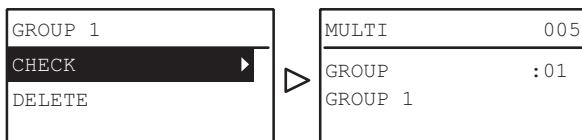

- To delete the specified recipient, select [DELETE] and then press \triangleright , then select [YES] and press [OK].

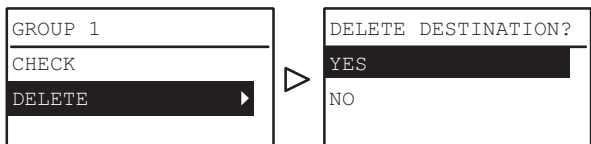

5 After you register all the recipients, select [COMPLETE] using \triangle or ∇ and press [OK].

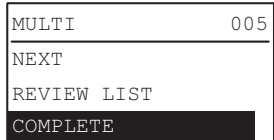

6 Once you have entered all recipients, press [START].

❑ Specifying the recipient from the address book

You can specify the recipient from the address book.

- It is required to register the address book beforehand.
 \square P.84 “Managing the Address Book”
- You can confirm the address book from the dialer list.
 \square P.47 “Dial list”

1 Press [ADDRESS BOOK].

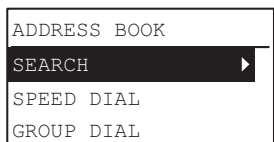
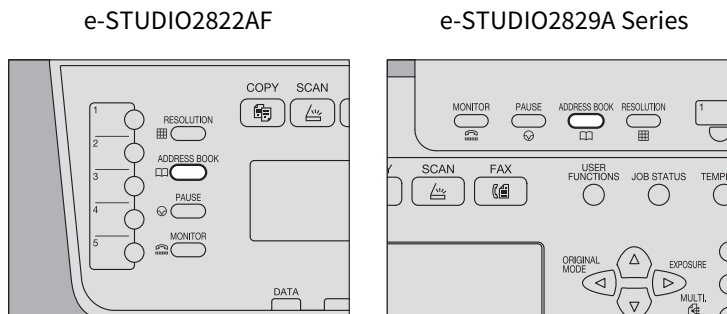

2 Specify the recipient.

- \square P.31 “Searching the recipient in the address book”
- \square P.32 “Speed Dial”
- \square P.33 “Group entry”

3 Press [Start].

Searching the recipient in the address book

You can search for a specific recipient in the address book.

1 Press \triangle or ∇ to select [SEARCH], and then press \triangleright .

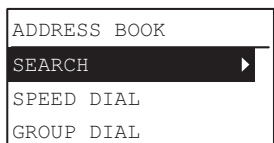

2 Press < or > to select the character string to use as the search key.

The search keys are displayed in the following order.

All → A-Z → 0-9 → ABC → DEF → GHI → JKL → MNO → PQR → STU → VWX → YZ → SD → GD

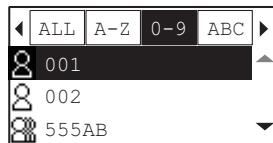

Tip

The search key “SD” means search for an individual (Single) while “GD” means search for a group (Group)

3 Press △ or ▽ to select a recipient, and then press [OK].

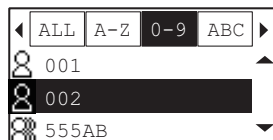

4 The registered names and fax numbers are displayed.

Press [OK].

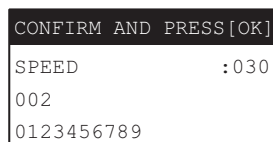

Speed Dial

You can specify the recipient using a Speed Dial number from 1 to 200.

- It is required to register the Speed Dial numbers beforehand.
P.84 “Managing the Address Book”
- You can confirm the Speed Dial numbers already registered.
P.51 “Speed Dial number list”

1 Press △ or ▽ to select [SPEED DIAL], and then press >.

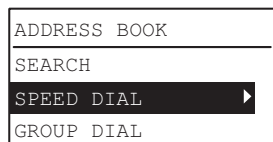

2 Enter the Speed Dial number using the digital keys.

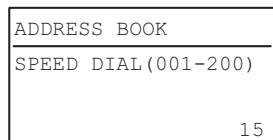

3 Press [OK].

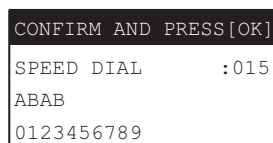

The already-registered names are displayed under Speed Dial.

- You can specify multiple recipients to send the same document at once. Repeat this operation until all the recipients are specified. You can also specify the recipients’ fax numbers by combining with other entry methods. The number of recipients you can simultaneously specify is limited to 220.

Group entry

You can specify the group to which you want to send a fax from the address book.

- It is required to register the groups beforehand.
📖 P.84 “Managing the Address Book”
- You can confirm the registration of groups from the Group number list.
📖 P.51 “Group Dial number list”

1 Press \triangle or ∇ to select [GROUP DIAL], and then press \triangleright .

ADDRESS BOOK
SEARCH
SPEED DIAL
GROUP DIAL \triangleright

2 Enter a group number using the digital keys, and then press [OK].

ADDRESS BOOK
GROUP DIAL (01-20)
12

3 Press [OK].

CONFIRM AND PRESS [OK]	
GROUP DIAL	:12
GROUP Q	

The already-registered group name is displayed.

- You can specify multiple groups to send the same document at once. Repeat this operation until all the recipients are specified. You can also specify the recipients' fax numbers by combining with other entry methods. The number of groups you can simultaneously specify is limited to 20.

Checking and Canceling the Transmissions

■ Checking Transmission Status (log)

Check the fax transmission log from the Transmission/Reception Journal.
For details, see the following page.
 P.50 “Activity Report (transmission and reception journal)”

■ Checking and canceling the reserved transmissions

1 Press [JOB STATUS].

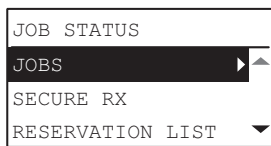
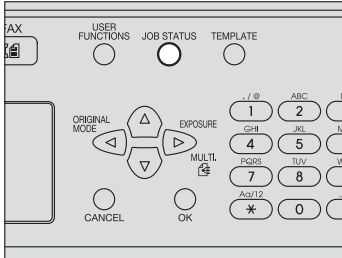

2 Press Δ , ∇ , \triangleright , or \triangleleft to select [JOBS] → [FAX], and then press \triangleright .

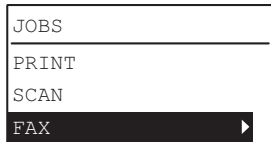

3 Press Δ or ∇ to select [CONFIRM], and then press \triangleright .

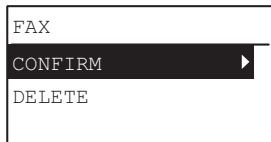

Tip

You can delete a reserved transmission by selecting [DELETE] and then pressing \triangleright . Press Δ or ∇ to select the reserved transmission you want to delete.
Select [YES], and then press [OK].

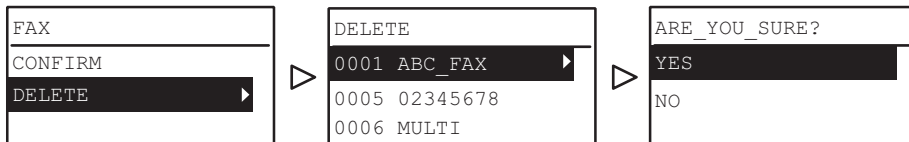

4 Press Δ or ∇ to select the row to confirm.

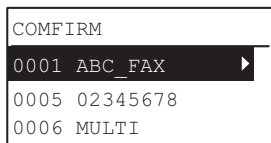

The transmission status is listed in the reverse chronological order from top to bottom.

5 Press **▷** to display the transmission status.

```
0001 ABC_FAX
20190324 13:15
TRANSMISSION
```

The status of each job is indicated as follows:

- TRANSMISSION: Sending on the line.
 REDIAL WAITING: Communication is in the redial standby queue.
 WAITING: Communication is in the standby queue.

■ Canceling transmission when an original is being scanned

You can cancel transmission during the scanning of an original.

1 Press **[CLEAR/STOP]** while the original is being scanned.

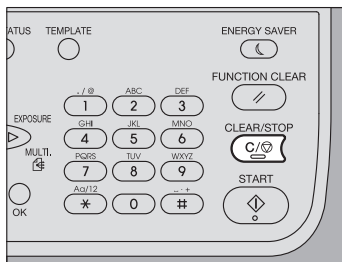

2 Select **[YES]**, and then press **[OK]**.

```
CANCEL JOB?
YES
NO
```

The scanning process is aborted.

RECEIVING A FAX

This chapter describes how to receive a fax.

Reception Mode	38
AUTO reception	38
Memory reception	38
Manual reception	38
Remote reception	39
Forwarding received faxes	39
Checking reception status (log)	39
Originals and Paper	40
Acceptable size of paper	40
Default setting for RX printing	40
Paper priority when there is no same size paper	40
Setting a Fax drawer	42
Printing SECURE RECEIVE Fax Jobs	44

Reception Mode

This section describes how to receive a fax. Refer to the appropriate section for your current reception mode.

■ AUTO reception

Faxes are automatically received during an incoming call. There is no need to do anything when receiving a fax.

Tip

Set [AUTO] in [RX MODE] of the USER FUNCTIONS menu beforehand.

 P.78 "FAX"

■ Memory reception

In the following conditions, faxes cannot be printed. If this happens, received fax data are stored in the memory, and printing is resumed as soon as this equipment is ready. As the memory reception function is always enabled, you do not need to make any setting.

- During copying or printing
- During printing of another fax
- During printing of lists and reports
- When paper has run out
- When a paper misfeed occurs
- When toner has run out

■ Manual reception

Faxes are received manually when you have an incoming call.

Note

Be sure to set [MANUAL] in [RX MODE] of the USER FUNCTIONS menu.

 P.78 "FAX"

Tip

Instead of picking up the handset of the external telephone, by pressing the [MONITOR] button with the following procedure, you can carry out the same operation.

- 1 Pick up the handset of the external telephone when you have an incoming call.**
If the incoming call is a telephone call, you can start talking.
- 2 If you hear a tone (fax signal) through the handset, press [FAX] and then [START].**
- 3 The following screen is displayed. Select [RX] and press [OK].**

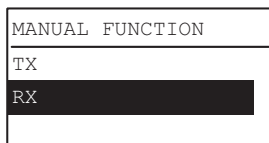

Tip

This screen does not appear if [EASY MANUAL TX/RX] is set to [EASY MODE].

 P.78 "FAX"

- 4 Put down the handset of the external telephone.**

■ Remote reception

Faxes are received by using an external telephone when you have an incoming call. This is convenient if the external telephone is installed away from this equipment.

Note

- For remote reception, an external telephone must be installed beforehand. If an external telephone is not installed, be sure to set [AUTO] in [RX MODE] of the USER FUNCTIONS menu.
📖 P.78 “FAX”
- Set [DIAL] in [REMOTE RX].
📖 P.78 “FAX”

1 Pick up the handset of the external telephone when you have an incoming call.

If the incoming call is a telephone call, you can start talking.

2 If you hear a tone (fax signal) through the external telephone, perform either of the following operations depending on the type of the lines being used.

Pulse line: Switch the mode to the tone line. Then press [5] and then [*] on the external telephone keypads. Put down the handset of the external telephone.

Tone line: Press [5] and then [*] on the external telephone keypads. Put down the handset of the external telephone.

Tip

The type of the lines can be identified by the sounds heard during dialing as below. For accurate information, confirm the contractual coverage subscribed to with your telephone carrier.

Pulse line (dial line): Sounds like the series of clicks heard when dialing

Tone line (push line): Sounds like a mixture of the two pure tones (pure sine wave) heard when dialing

■ Forwarding received faxes

Received fax images can be sent by an e-mail or be transferred to a network folder. For forwarding received faxes, be sure to set it through TopAccess in advance. For details, refer to the **TopAccess Guide**.

■ Checking reception status (log)

Check the fax reception log by printing the Transmission/Reception Journal. For details, see the following page.

📖 P.50 “Activity Report (transmission and reception journal)”

Originals and Paper

Acceptable size of paper

LD, LG, LT, LT-R, ST-R, COMP, A3, A4, A4-R, A5-R, B4, B5, B5-R, FOLIO, 8K, 16K, and 16K-R size paper can be used. Acceptable sizes of paper are different between e-STUDIO2822AF and e-STUDIO2829A Series. See the following page for details.

 P.95 “Specifications of Fax”

The printing range of each size of paper is as follows: As shown in the figures below, if an original document contains any information in the shaded area, it is not printed on the paper.

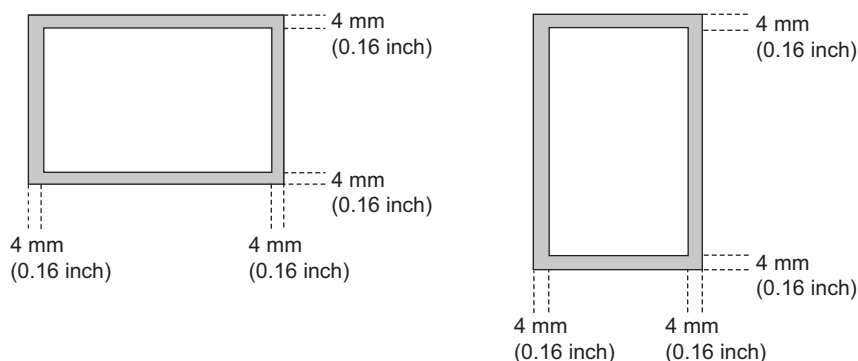

Tip

- The paper set on the bypass tray cannot be used.
- A drawer exclusive for fax can be set. See the following page for details.
 P.42 “Setting a Fax drawer”

Default setting for RX printing

To print the received fax, the paper with the same width as the original is used. Depending on the length of the original, “RXPRINT - REDUCTION” or “RXPRINT - DISCARD” (both of them are set to ON by manufacturer default) are applied.

This function operates based on the settings made by the administrator, and as such no user operations may be necessary. For details of the setting operation, see the following page.

 P.78 “FAX”

When an original is shorter or the same as the paper printing area

It is printed in the original size.

When an original is longer than the paper printing area

It is printed according to the following priority:

- When an original is up to 10 mm (0.4 inch) longer than the printing area: the part of the original that exceeds the paper printing area is discarded.
- When an original exceeds the printing area by more than 10 mm (0.4 inch), the original image is reduced by one size for printing (reduction printing). If the image still cannot be fitted into the printing area, paper larger than the original is selected. In case there is no larger paper available, the original is printed with the image divided.

Paper priority when there is no same size paper

When both “RXPRINT - REDUCTION” and “RXPRINT - DISCARD” are set to ON, paper is selected according to the following priority:

1. Paper of the same size and the same orientation as the original
2. Paper of the same size but with a different orientation to the original
3. Paper of the same orientation but larger than the original

North American format

Size of Original being Received Priority	Ledger	Legal	Letter	Letter	Statement	COMP
1	Ledger	Legal	Letter	Letter	Statement	COMP
2		Letter Reduced to 75%	Letter	Letter	Letter	Ledger
3		Letter Reduced to 75%	Ledger	Legal	Letter	
4		COMP	Legal	COMP	Legal	
5		Ledger	COMP	Ledger	COMP	
6					Ledger	

* Acceptable sizes of paper are different between e-STUDIO2822AF and e-STUDIO2829A Series. See the following page for details.  P.95 "Specifications of Fax"

Note

- When the corresponding paper size is not available, in most cases, the scanned original is printed on paper of a larger size. However, the sender's fax machine may reduce the scanned original to fit the paper size available in the recipient's fax machine (this equipment). (Ex. LD → LT)
- The paper priority varies according to the "RXPRINT - REDUCTION" and "RXPRINT - DISCARD" settings. For details, contact your service technician.

A/B format

Size of Original being Received \ Priority	A3	B4	A4	A4	B5	A5	FOLIO
1	A3	B4	A4	A4	B5	A5	FOLIO
2		A3	A4	A4	B5	A4	B4
3			A3	B4	B4	A4	A3
4			B4	A3	A4	B5	A4 Reduced to 75%
5					A4	B5	A4 Reduced to 75%
6					A3	B4	
7						A3	

* Acceptable sizes of paper are different between e-STUDIO2822AF and e-STUDIO2829A Series. See the following page for details.  P.95 "Specifications of Fax"

Note

- When the corresponding paper size is not available, in most cases, the scanned original is printed on paper of a larger size. However, the sender's fax machine may reduce the scanned original to fit the paper size available in the recipient's fax machine (this equipment). (Ex. A3 → A4)
- The paper priority varies according to the "RXPRINT - REDUCTION" and "RXPRINT - DISCARD" settings. For details, contact your service technician.

■ Setting a Fax drawer

A drawer exclusive for fax can be set for Fax reception. In this setting, only the paper in the Fax drawer is used for printing received data.

Tip

When the incoming original is larger than the recording paper, it is printed according to the setting of "RXPRINT - REDUCTION" or "RXPRINT - DISCARD".

 P.40 "Default setting for RX printing"

1 Press [USER FUNCTIONS].

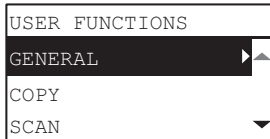
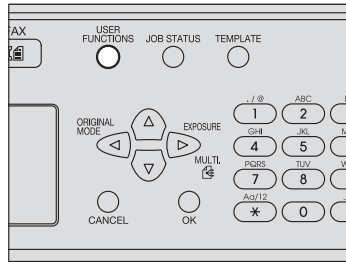

2 Press Δ , ∇ , \triangleright , or \triangleleft to select [FAX] \rightarrow [RX PRINT], and then press \triangleright .

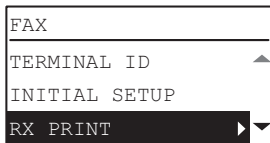

3 Press Δ or ∇ to select [FAX DRAWER SETTING], and then press \triangleright .

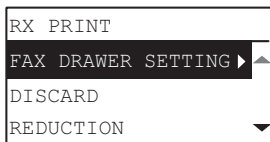

4 Select the desired Fax drawer using Δ or ∇ and press [OK].

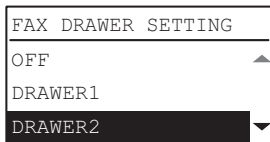

To clear the setting, select [OFF] (default value).

Printing SECURE RECEIVE Fax Jobs

When the [Fax] button on the control panel blinks, there is a received SECURE RECEIVE fax job. You can print the fax data by entering your PRINT PASSWORD.

 P.14 “Control panel”

1 Press [JOB STATUS].

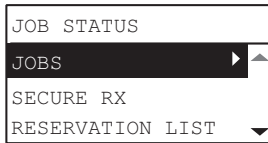
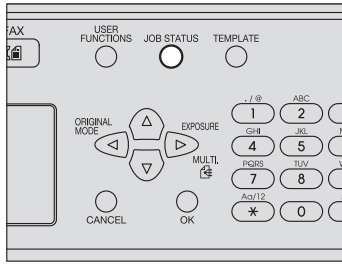

2 Press Δ or ∇ to select [SECURE RX], and then press \triangleright .

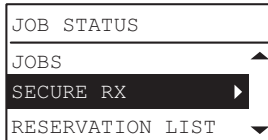

3 Enter the password for printing a received SECURE RECEIVE fax, and then press [OK] to start printing.

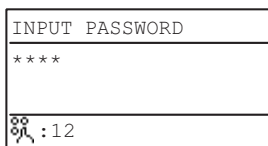

PRINTING LISTS AND REPORTS

This chapter explains how to print lists and reports.

Printing Lists & Reports Manually	46
Journal (transmission and reception journal)	46
Reservation list.....	47
Dial list.....	47
Printing Lists & Reports Automatically	49
List/Report Samples	50
Activity Report (transmission and reception journal).....	50
Memory Data List (reservation list)	50
TX Result Report (memory transmission report)	51
Dial list.....	51

Printing Lists & Reports Manually

You can print lists and reports (journals) manually. For samples of lists and reports, see the following page.

 P.50 “List/Report Samples”

Tip

- Lists and reports are printed on LT/A4-size paper. If this equipment has run out of LT/A4-size paper, lists and reports will be printed on larger sized paper.
- The Transmission/Reception Journal, Memory-TX Report, and Multi-add Report are printed from a Fax drawer. For details on the Fax drawer, see the following page.
 P.42 “Setting a Fax drawer”
- In addition to the lists described in this section, you can print lists, such as the function list, manually. For details on the operation, see the **User’s Guide**.

■ Journal (transmission and reception journal)

You can print a list of transmissions and receptions. This equipment logs up to the latest 60 transmission/reception records.

1 Press [JOB STATUS].

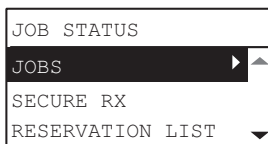
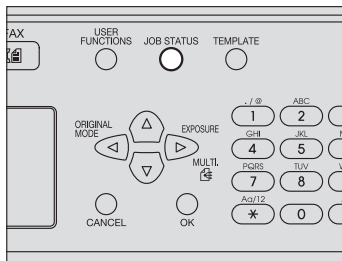

2 Press Δ or ∇ to select [JOURNAL].

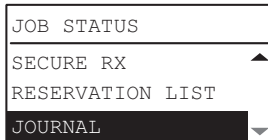

3 Press [OK] to start printing.

 P.50 “Activity Report (transmission and reception journal)”

Reservation list

You can print a list of the reserved transmissions.

1 Press [JOB STATUS].

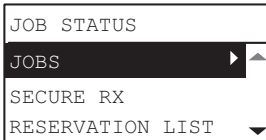
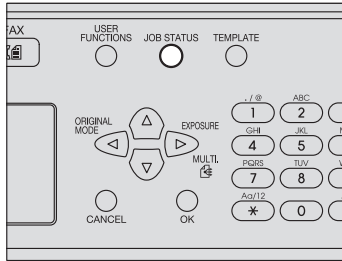

2 Press Δ or ∇ to select [RESERVATION LIST].

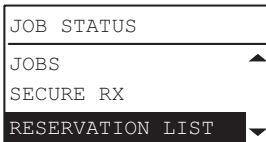

3 Press [OK] to start printing.

P.50 “Memory Data List (reservation list)”

Dial list

You can print the list of Speed Dial numbers, Group Dial numbers, and One Touch Dial key numbers that are registered in the Address Book.

1 Press [USER FUNCTIONS].

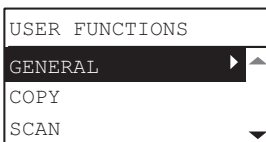
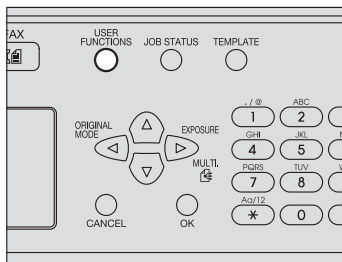

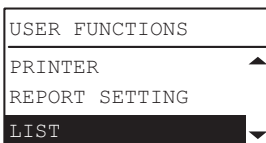

2 Press Δ or ∇ to select [LIST], and then press \triangleright .

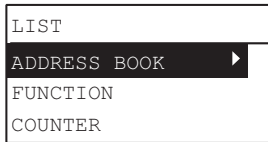

3 Press Δ , ∇ , \triangleright , or \triangleleft to select [ADDRESS BOOK].



4 Press \triangleright , select any one of the following with Δ or ∇ , and then press [OK]. Printing will start.



- SPEED DIAL: Prints a list of the fax number and telephone number of the registered Speed Dial numbers.
 P.51 "Speed Dial number list"
- GROUP DIAL: Prints a list of the group names, registered numbers and One Touch Dial keys.
 P.51 "Group Dial number list"
- ONE TOUCH: Prints a list of the Speed Dial numbers and group numbers registered in the One Touch Dial keys.
 P.52 "One Touch Dial key list"

Printing Lists & Reports Automatically

You can print lists and reports automatically. For samples of lists and reports, see the following page.

 P.50 “List/Report Samples”

Tip

- Lists and reports are automatically printed according to the settings that the administrator made, so no user operation is required. For details of the setting operation, see the following page.
 P.81 “REPORT SETTING”
- The Activity Report and TX Result Report are printed from a Fax drawer. For details on the Fax drawer, see the following page.
 P.42 “Setting a Fax drawer”

Lists/reports that can be printed automatically are as follows:

Activity Report (transmission and reception journal)

When this equipment completes 60 transmission and reception jobs, the journal is printed.

TX Result Report

When the transmission or multi-address transmission is completed, the report is printed. (You have an option to add a reduced image of the transmitted document.)

List/Report Samples

Activity Report (transmission and reception journal)

Sender's Fax number
Terminal ID
Outputting date and time
Page Number

Activity Report

Page 001
Date 2019/05/10 20:05
Name Aaabbb L.A.
Fax Number 2131235678

File No.	Date	Time	Duration	Pages	Destination	TX/RX/FW	Status
0001	05/07	16:59	02' 21	001	Redfield HS	TX	OK
0002	05/08	17:33	00' 50	002	2123456789	RX	Err00B5

TX, RX or FW
Communication result and error code
OK: Succeeded
Err + 4-digit error code: Failed

File number of communication
Date and time when communication started
Duration of communication
The number of pages for the communication
Terminal ID or telephone number of destination/origin of communication

Memory Data List (reservation list)

Memory Data List

Page 001
Date 2019/05/10 20:05
Name Aaabbb L.A.
Fax Number 0131235678

File No.	Date	Time	Pages	Destination	Unsent	Status
0001	05/10	16:59	009	12345678901234567890	-	OK
		17:10		1234567890	p1-9	Error
		17:20		ABCD	-	Transmitting
0002		17:33	002	2123456789		

Unsent page
Communication Status
Waiting: Wait for transmission
Transmitting: During transmission
OK: Transmission was normally completed.
Error: Redial all fail.

■ TX Result Report (memory transmission report)

TX Result Report

Page 001
 Date 2019/05/10 20:05
 Name Aaabb L.A.
 Fax Number 0131235678

File No.	Date	Time	Pages	Destination	Unsent	Status
0001	05/10	16:59	009	12345678901234567890		OK

1st Page Image

■ Dial list

☐ Speed Dial number list

Speed Dial List

Page 001
 Date 2019/5/10 11:48
 Name ABCDEFGHI
 Fax Number 01234567890

Speed Dial No.	Name	Number / Address
001	ABCDEFGHIJKLMNQRST	0P00*1234567890
002		01234567
003	1234QRST	03456789012345
004		ZZXX@aaa.bbb.ccc
050		01234567890123
051	3F-MFP	012345678901234
052	4F-MFP	0123456789012345
054		012345678901234567890

Speed Dial number Recipient's terminal ID Recipient's Fax/telephone number or e-mail address

☐ Group Dial number list

Group Dial List

Page 001
 Date 2019/5/10 11:48
 Name ABCDEFGHI
 Fax Number 01234567890

Group No.	Name	OT/SP	Number	OT/SP Name
01	ABC-GROUP	OT	001	OT1
		OT	004	ABC-Tokyo
		SP	054	ABC-MFP
20	1234QRST	SP	003	012345678

Group number Group name Type
 OT: One Touch Dial key number
 SP: Speed Dial number

One Touch Dial key number /Speed Dial number Recipient's One Touch Dial key number or Speed Dial number registered in the group

❑ One Touch Dial key list

One Touch Dial List

Page 001
Date 2019/5/10 11:48
Name ABCDEFGHI
Fax Number 01234567890

One Touch No.	Name	Number
01	ABCDEFGHIJKLMNQRST	0P00*1234567890
02		01234567
03	1234QRST	03456789012345
04	OneTouch4	01234567890123
05		

One Touch Dial key number

Recipient's terminal ID or type of registration

Recipient's Fax/telephone number

SENDING A N/W-FAX

This chapter describes the Network Fax function.

Features and Functions	54
Features.....	54
Functions.....	54
Faxing from Applications	55
How to fax using the N/W-Fax driver.....	55
Specifying recipients	57
Setting up the network fax options.....	59
Sending with extended fax functionality.....	62
Managing Address Book	65
Opening and creating the address book	65
Managing contacts and groups.....	66

Features and Functions

The network fax functions of this equipment allow you to make direct fax transmission of electronic documents from your computer.

📖 P.54 “Features”

📖 P.54 “Functions”

Tip

When you fax hard copies, not electronic documents, fax them using the control panel of this equipment.

■ Features

- When the N/W-Fax driver is installed, you can transmit electronic documents as fax data from your computer to several destinations.
- When you fax documents, you can easily set the list for the destinations of the fax data.
- When you fax documents, you can attach an embedded cover sheet on them. Information about the fax documents and their detailed messages can be included in this cover sheet.
- The destinations of the fax can be entered manually, or can be selected from the address book data. In this method, you can easily search for the desired addresses throughout the address book.
- Since the image data processing methods for network fax documents and regular fax documents differ, the image quality for network fax documents may vary compared with that for regular fax documents.

■ Functions

The N/W-Fax driver allows you to make fax transmission of documents created in your computer. In a normal procedure, select the [Print] menu in the application in which the documents were created, select this driver (TOSHIBA e-STUDIO2829A Series Fax), and then start printing. The documents are then transmitted to this equipment. This equipment then transmits the documents to outside fax machines through public switched telephone networks.

In fax transmission using the N/W-Fax driver, you can enter the destination of the fax manually or retrieve the desired destinations from the address book data.

Faxing from Applications

The N/W-Fax driver allows you to fax document data from your computer to several destinations. It also enables the setup of the fax properties and editing of the sender's information.

📖 P.55 "How to fax using the N/W-Fax driver"

📖 P.57 "Specifying recipients"

Tip

Check if all the fax settings of this equipment have been done prior to fax transmission.

■ How to fax using the N/W-Fax driver

Follow the procedure below to fax document data from your computer with the N/W-Fax driver installed.

- Create a document.
- Print to N/W-Fax driver.
- Select recipients and fax numbers.
- Select a cover page (optional).
- Send the fax.

📖 P.55 "Preparing documents for faxing"

📖 P.55 "Faxing from Windows applications"

❑ Preparing documents for faxing

To see how objects, such as headers, footers, or drawing objects, will be positioned on a fax page, switch to your applications' page layout view. If the software application you are using provides a Print Preview option, you can use it to view your fax before it is sent.

❑ Faxing from Windows applications

Once you have installed the N/W-Fax driver, you can send the document directly from most Windows applications as a fax.

1 Open the file and select [Print] from the [File] menu of the application.

The Print dialog box appears.

2 Select [TOSHIBA e-STUDIO2829A Series Fax] and click [Print].

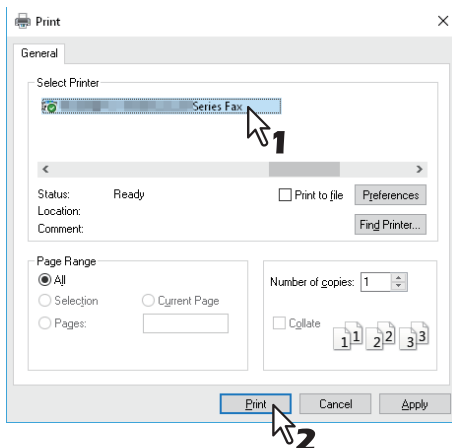

The [Destination Tool] dialog box appears.

3 Display the [Address Book] tab and specify the recipients.

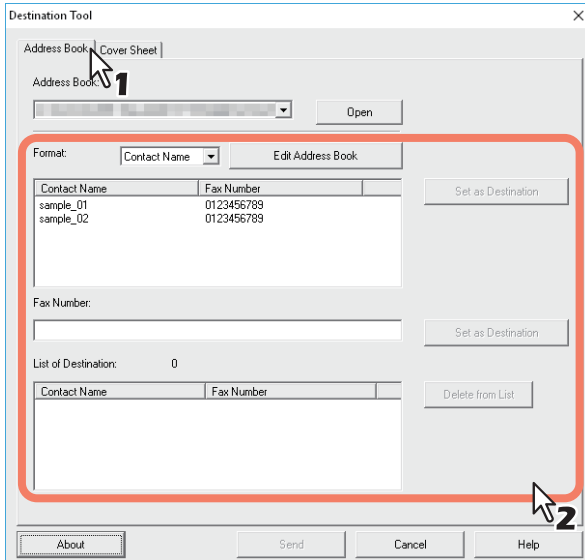

P.57 “Specifying recipients”

4 Display the [Cover Sheet] tab and specify the cover sheet properties if you want to send a document with a fax cover sheet.

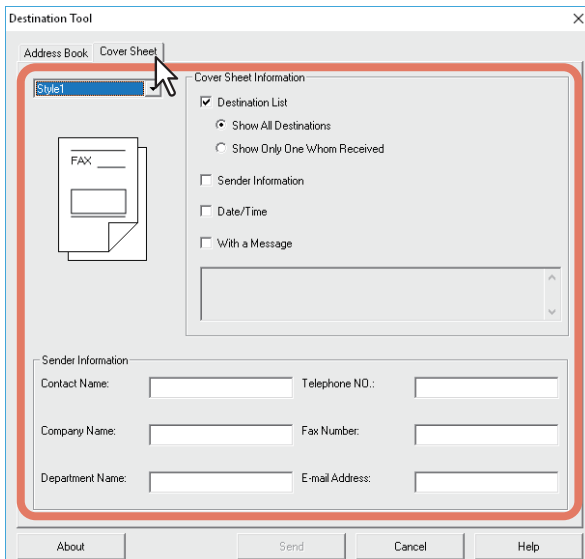

P.61 “Setting up the cover sheet properties”

5 Click [Send] to send the document.

Tip

A dialog box requiring the entry of the department code appears if no department code or an incorrect one is entered when the department management function is performed in this equipment. In such a case, enter the correct department code and click [Continue].

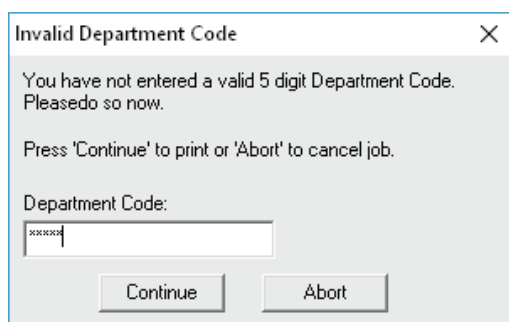

■ Specifying recipients

You can specify the recipients using the following methods:

📖 P.57 “Specifying recipients from address book”

📖 P.58 “Entering a fax number manually”

Also you can remove the recipients added to the [List of Destination] field.

📖 P.59 “Removing recipients from the [List of Destination] field”

Tip

You can specify up to 100 recipients.

□ Specifying recipients from address book

1 Click [Open] in the [Address Book] tab to open the address book.

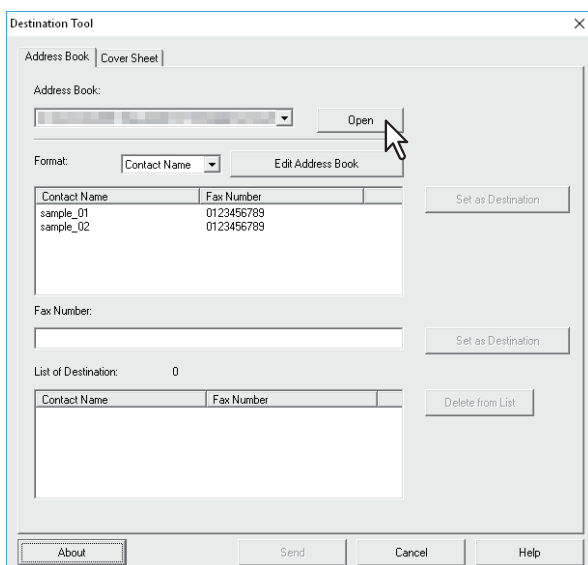

Registered contacts are displayed in the window.

Tip

- The [Format] box enables you to change display format. Selecting “Contact Name” will display individual records. Selecting “Group” will display group record.
- To utilize the address book, you must register contact information into the address book in advance. For this registration, see the following page.
📖 P.65 “Managing Address Book”

2 After selecting a contact from the contact list, click [Set as Destination].

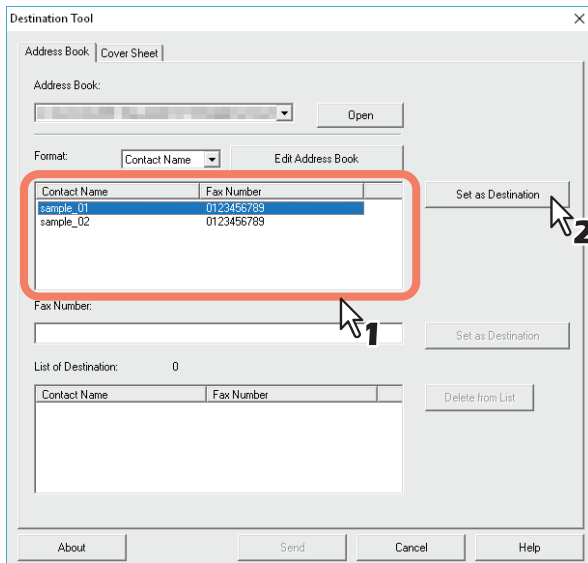

The selected recipients are listed in the [List of Destination] field.

You can also select a recipient by the following operations:

Selecting a contact by double-clicking on it

Double click the contact in the contact list to include it in the [List of Destination] field.

Removing a recipient

Select a recipient in the [List of Destination] field and click [Delete from List].

❑ Entering a fax number manually

1 Enter a fax number in the [Fax Number] field and then click [Set as Destination].

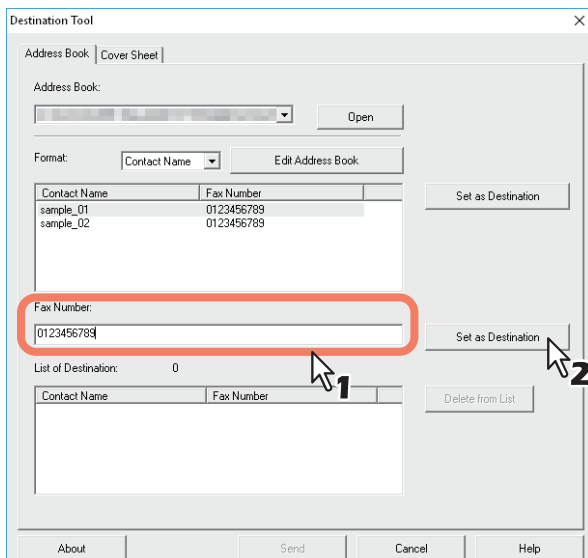

The entered fax number is added to the [List of Destination] list.

Tip

- You can enter up to 128 numbers and symbols in the [Fax Number] field. Symbols you can use are “T”, “*”, “#”, and “_”.
- You cannot use “-” as first character in the [Fax Number] field.

❑ Removing recipients from the [List of Destination] field

- 1 Select the recipient you want to remove from the [List of Destination] field, and then click [Delete from List].

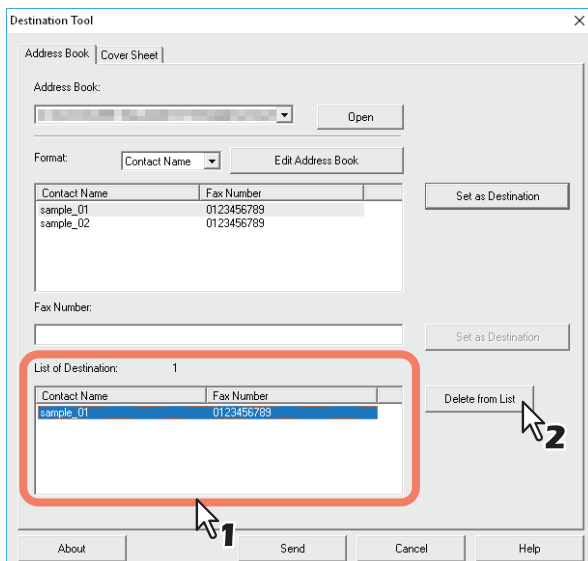

The selected recipient is removed from the [List of Destination].

■ Setting up the network fax options

Network fax options are the attributes you set to define the way a fax job is transmitted. For example, you can specify properties such as the recipients and cover sheet.

📖 P.59 “Setting the address book properties”

📖 P.61 “Setting up the cover sheet properties”

Tip

You can send a fax with a cover sheet. See the following page for details.

📖 P.62 “Sending with extended fax functionality”

❑ Setting the address book properties

In the [Address Book] tab of the network fax properties dialog box, you can specify the recipients.

Tip

To specify the recipients, you can select from the address book or enter the fax number manually.
📖 P.57 “Specifying recipients”

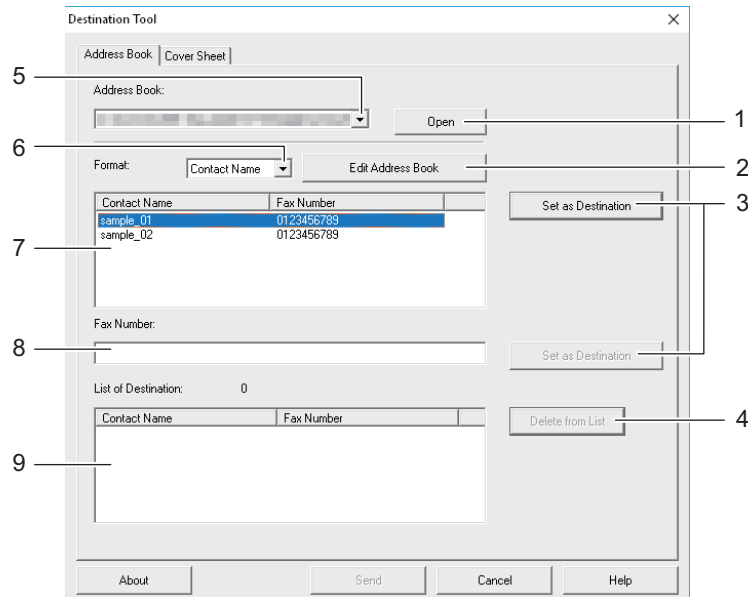

- 1. [Open]**
Click to open the address book.
- 2. [Edit Address Book]**
Click to open the Edit Address Book window.
- 3. [Set as Destination]**
Click to add a recipient or fax number to the [List of Destination] field.
- 4. [Delete from List]**
Select a recipient in the [List of Destination] field and click this button to remove the recipient from the list.
- 5. [Address Book] box**
Displays up to three most recently opened address books.
- 6. [Format] box**
Enables you to change display format.
- 7. Contact list**
Displays contacts registered in the address book.
- 8. [Fax Number] field**
Enables you to enter a fax number manually.
- 9. [List of Destination] field**
Displays selected recipients.

❑ Setting up the cover sheet properties

In the [Cover Sheet] tab of the network fax properties dialog box, you can specify the fax cover sheet to be sent. If you enable the cover sheet, the cover sheet is attached in the first page of the document and sent to the recipients.

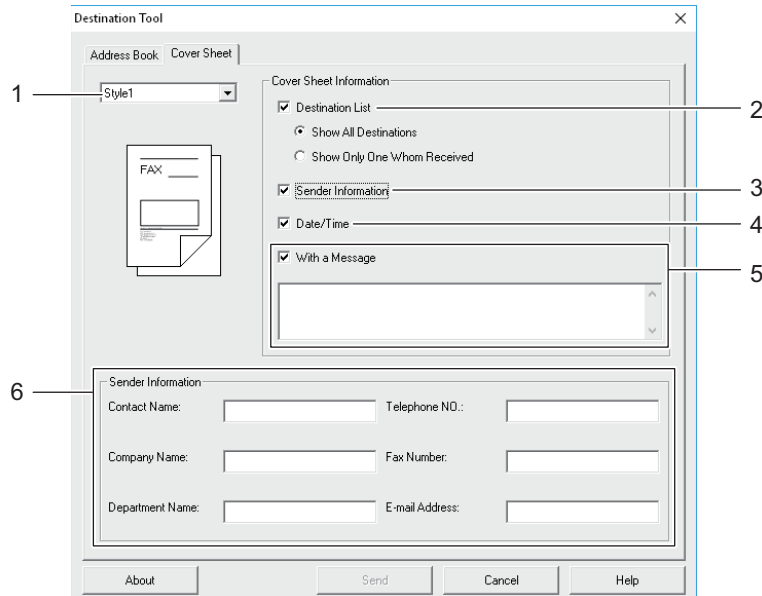

1. Select cover sheet

Select the cover sheet type from the box.

2. Destination List

Check this to print recipient information on the cover sheet. Selecting “Show all Destinations” will print all recipients. Selecting “Show Only One whom Received” will print the recipient at the top of the [List of Destination] field.

3. Sender Information

Check this to print sender information entered in the [Sender Information] fields on the cover sheet.

4. Date/Time

Check this to print date and time on the cover sheet.

5. With a Message

Check this to enter the message to appear on the cover sheet. You can enter up to 256 characters.

6. Sender Information

Enter sender information in the fields to be printed on the cover sheet. You can enter up to 64 characters in each field.

■ Sending with extended fax functionality

The N/W-Fax driver allows users to perform the following operations.

- 📖 P.62 “Sending with a cover sheet”
- 📖 P.63 “Setting up the fax driver options”

❑ Sending with a cover sheet

You can choose to send a cover sheet with your fax transmission. The cover sheet is merged with the recipient [List of Destination] data to create a fax cover sheet. You can select what to include on the cover sheet such as sender or recipient information.

1 Display the [Cover Sheet] tab and select the cover sheet type from the drop-down menu.

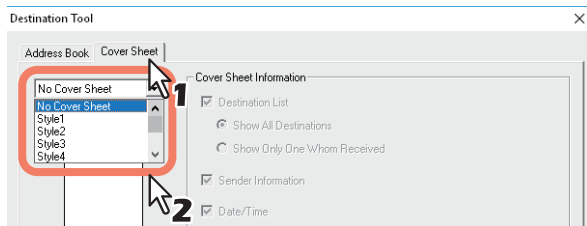

2 Select options in [Cover Sheet Information].

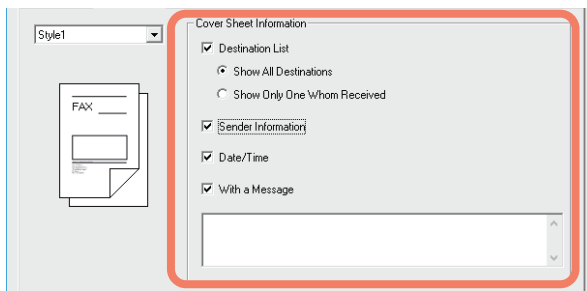

3 Enter the sender information in the [Sender Information] fields if [Sender Information] box is checked.

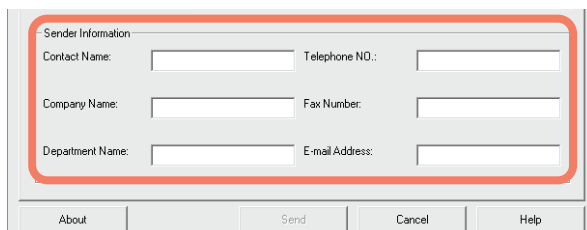

You can enter up to 64 characters in each field.

4 Enter the message to appear on the cover sheet if the [With a Message] box is checked.

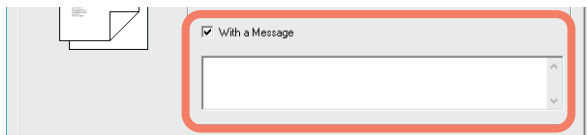

You can enter up to 256 characters for the message.

5 Click [Send] to send the document to this equipment.

❑ Setting up the fax driver options

You can set the paper size, orientation, and resolution etc. of the fax job in the printing preferences.

1 Open the printers folder.

Click [Start] and select [Settings] > [Devices] > [Devices and Printers].

Tip

- For Windows 8.1 / Windows Server 2012 or later, right-click in the lower left of the screen, then click [Control Panel] > [Devices and Printers].
- For Windows 7, click [Start] > [Devices and Printers].
- For Windows Server 2008, click [Start] > [Control Panel] > [Hardware and Sound] > [Printers].

2 Right-click [TOSHIBA e-STUDIO2829A Series Fax], and then select [Printing Preferences] from a shortcut menu.

Tip

- When using Windows Server 2008, select [TOSHIBA e-STUDIO2829A Series Fax], click the [File] menu and then select [Printing Preferences].
- If [File] menu is not displayed, press [Alt].

3 Set the following options and click [OK].

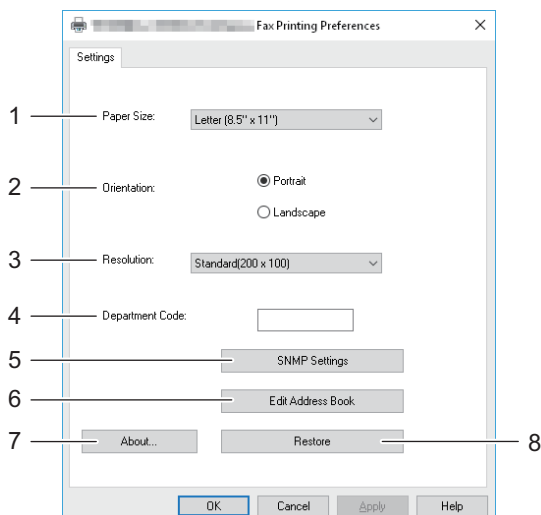

1. Paper Size

Select the size of paper to be used for fax transmission.

2. Orientation

Select the printing direction of the fax transmission.

3. Resolution

Select the resolution to be used for fax transmission.

4. Department Code

Enter a department code when the department management function is enabled in this equipment.

5. SNMP Settings

Click to check or change the SNMP settings.

📖 P.64 “SNMP settings”

6. Edit Address Book

Click to edit the Address Book.

7. About

Click to check the FAX driver version.

8. Restore

Click to restore the values of the FAX driver settings to the default.

Note

Even though no department code or an incorrect one is entered, a print job is transmitted if [Print] has been set for [Invalid Department Code Print Job] in TopAccess. If [Delete] has been set, the print job is deleted.

SNMP settings

If the recipient's Toshiba MFP is not found over the network and the fax job is not sent normally, the SNMP settings may be the cause. Check that the SNMP settings are correct in the [SNMP Settings] dialog box, and if not, change them.

Note

Ask the administrator for details on the SNMP settings configured for your Toshiba MFP.

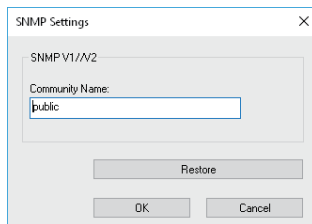

Community Name: If a community name other than “public” (default) is set for the SNMP community name for your Toshiba MFP, change it.

Note

- To send fax jobs normally, the same SNMP community name must be set in both this equipment and the FAX driver. For details, ask your administrator.
- Up to 31 characters including the following symbols can be entered for the Community Name.
! " # \$ % & ' () * + , - / : ; < = > ? @ [\] ^ _ ` { | } ~

Managing Address Book

You can add or edit the contacts and groups in the address book as you desire. The address book data is stored in your client computer. It can be used to manage the contacts and groups for sending a fax using the N/W-Fax driver.

📖 P.65 “Opening and creating the address book”

For instruction on how to manage the contacts and groups in the address book, see the following page:

📖 P.66 “Managing contacts and groups”

■ Opening and creating the address book

The address book file created as a CSV file can be opened in the Edit Address Book window. If you do not have an address book, you can create a new one.

Note

For more information about the format, please contact your service technician.

❑ Opening the address book from a CSV file

1 Click [New/Open].

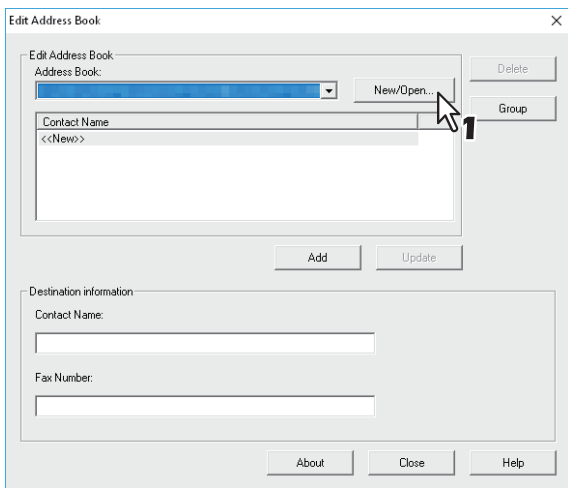

The [Open] dialog box appears.

2 Locate the folder where the CSV file is stored, and select the file type in the [Files of types] box. Then select the file and click [Open].

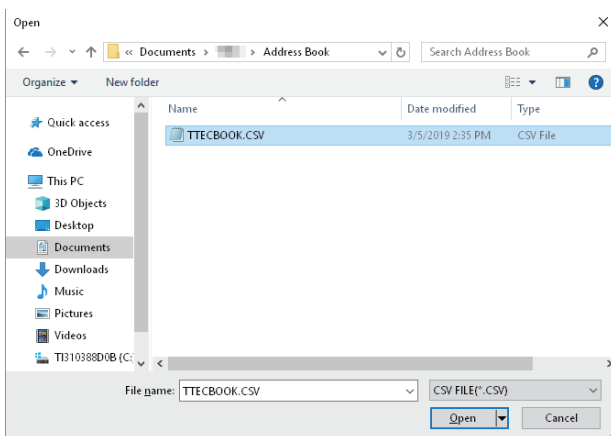

Note

You can enter the name of the file in “File name” to create a new address book.

3 The address book data is opened and contact names are displayed in the Contact list.

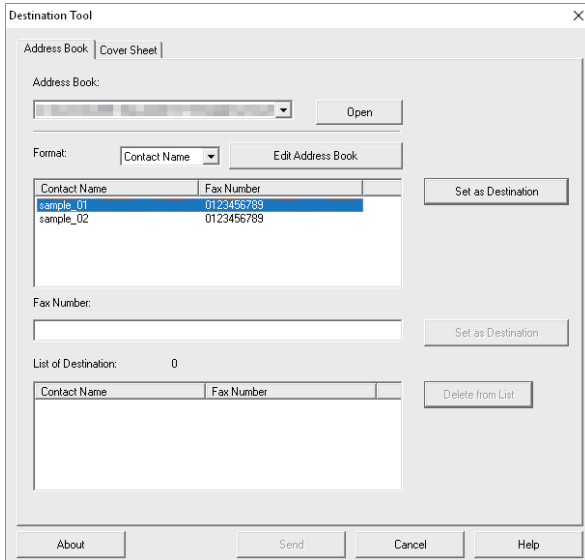

Tip

Up to three most recently opened address books are listed in the [Address Book] box.

Managing contacts and groups

You can manage contacts or groups in an address book.

The address book allows you to register up to 150 contacts and sort them into groups arbitrarily created. You can create up to 10 groups per address book and register up to 100 contacts in each group.

📖 P.66 “Managing contacts”

📖 P.69 “Managing groups”

Managing contacts

You can add, edit, or delete contacts in an address book.

📖 P.66 “Adding a new contact”

📖 P.68 “Removing a contact from address book”

Adding a new contact

You can add new contacts to the address book.

1 Click [Edit Address Book] in the [Address Book] tab.

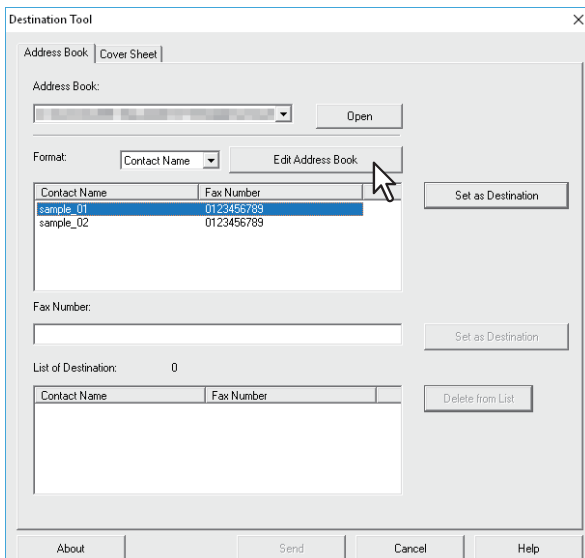

The Edit Address Book dialog box appears.

2 Click “<<New>>” in [Contact Name] field and enter contact details in [Contact Name] and [Fax Number].

The screenshot shows the 'Edit Address Book' dialog box. At the top, there is a dropdown menu for 'Address Book' and a 'New/Open...' button. Below this is a 'Contact Name' field containing '<<New>>'. A red box highlights the 'Destination information' section, which contains 'Contact Name' and 'Fax Number' fields. The 'Add' button is located below the 'Destination information' section. A mouse cursor points to the '<<New>>' text in the 'Contact Name' field (labeled '1') and to the 'Add' button (labeled '2').

Tip

- You can enter up to 20 characters in the [Contact Name] field.
- You cannot use “,” in the [Contact Name] field.
- You can enter up to 50 numbers and symbols in the [Fax Number] field. Symbols you can use are “T”, “*”, “#”, and “-”.
- You cannot use “-” as first character in the [Fax Number] field.

3 Click [Add].

The screenshot shows the 'Edit Address Book' dialog box after clicking the 'Add' button. The 'Contact Name' field now contains 'sample_01' and the 'Fax Number' field contains '0123456789'. The 'Add' button is highlighted with a mouse cursor.

The contact is added to the address book.

Tip

If you want to edit information on existing contact, click [Update] after editing the information in the Destination Information field.

Removing a contact from address book

You can remove contacts from an address book.

- 1 Open the address book that contains the contact you want to remove.
- 2 Select the contact you want to remove in the [Contact Name] field and click [Delete].

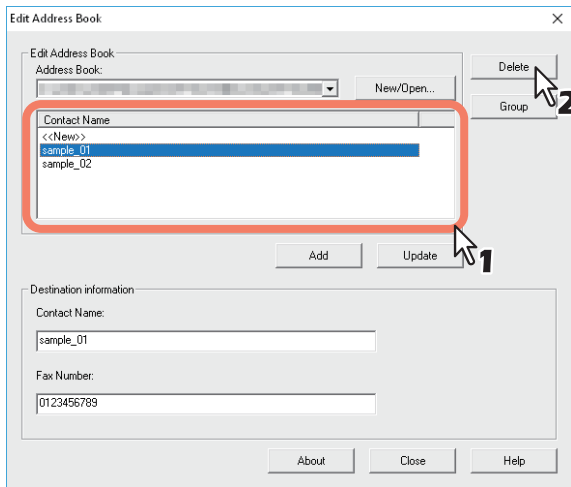

The confirmation dialog box appears.

- 3 Click [OK].

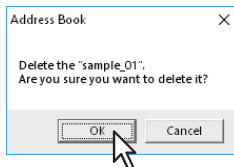

The selected contact is removed.

❑ Managing groups

You can add groups to an address book. Groups can be used for multi-address transmission.

📖 P.69 “Creating groups”

Also you can modify or delete groups in the address book.

📖 P.70 “Modifying a group name”

📖 P.71 “Removing group”

After you create a group, you can add or delete contacts in the group. For the instruction to add contacts in a group, see the following page.

📖 P.66 “Managing contacts”

Creating groups

You can create groups in the address book.

1 Click [Group] in the Edit Address Book dialog box.

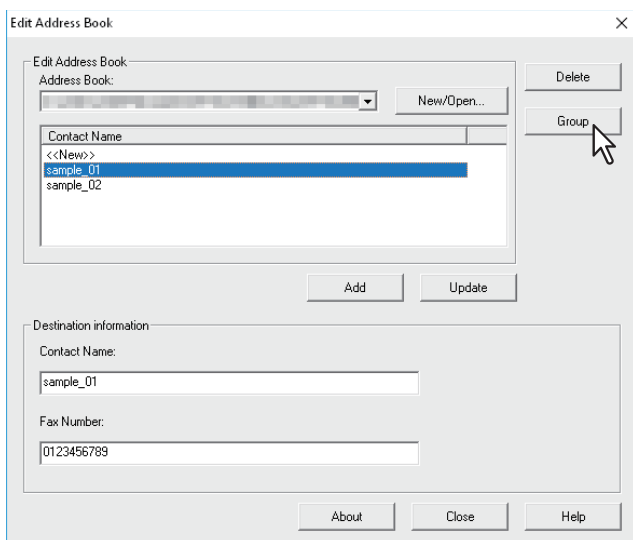

The Group dialog box appears.

2 Click [New].

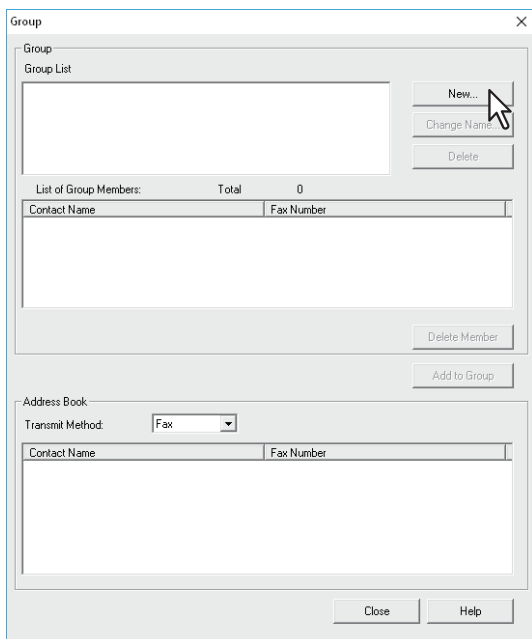

The New Group dialog box appears.

3 Enter a group name in the [Group Name] field.

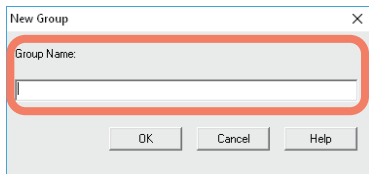

Tip

- You can enter up to 20 characters in the [Group Name] field.
- You cannot use “,” and “|” as a group name.

4 Click [OK].

The group is created in the “Group” field.

5 Proceed to add contacts to the group.

 P.66 “Managing contacts”

Tip

You can add up to 100 contacts to a group.

Modifying a group name

You can change the group name of groups in the address book.

Note

Properties cannot be modified when they have been opened from the address book.

1 Select the group whose name you want to modify from the [Group List] field.

2 Click [Change Name].

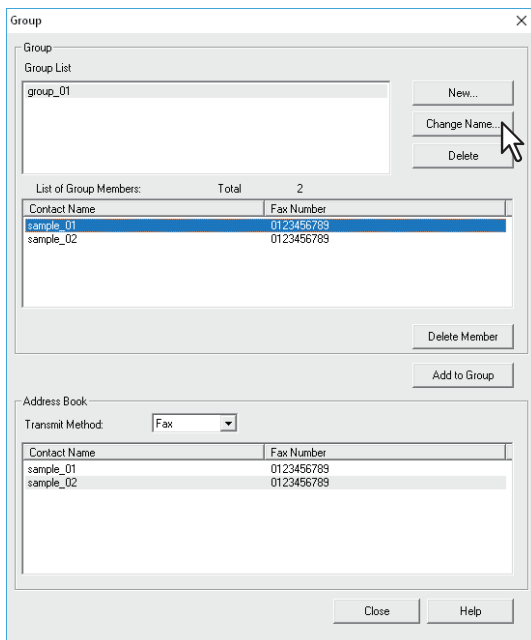

Contact Name	Fax Number
sample_01	0123456789
sample_02	0123456789

The [Change Name] dialog box appears.

3 Modify the group name in the [Group Name] field and click [OK].

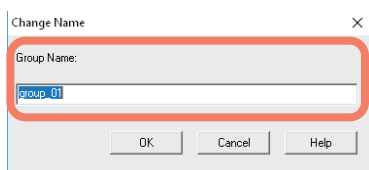

The group name of the selected group is modified.

Removing group

You can delete groups in the address book.

- 1 Select the group that you want to remove from the [Group List] field.
- 2 Click [Delete].

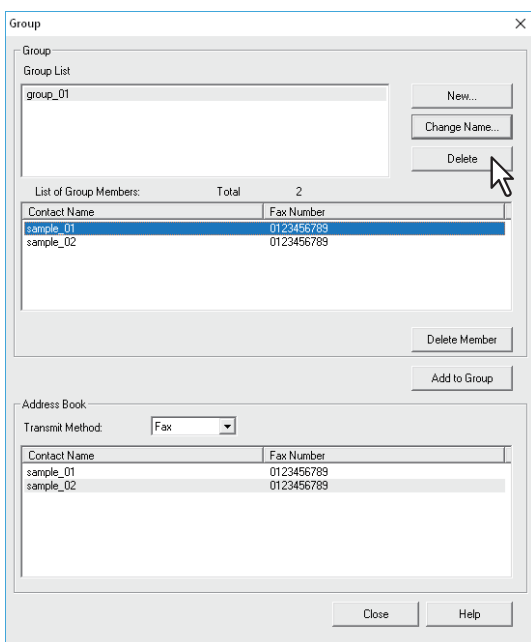

The confirmation dialog box appears.

- 3 Click [OK].

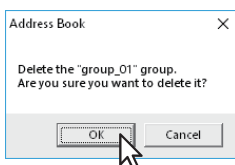

The selected group is removed.

SETTING ITEMS

This chapter describes the user and administrator settings related to the fax function.

Operating the USER FUNCTIONS Menu	74
Character Entry	75
Switching the input mode	75
Entering characters.....	75
Relationship between the digital keys and the input character	76
User Functions Menu Items	77
User functions menu items	77
FAX	78
REPORT SETTING	81
LIST	81
ADDRESS BOOK.....	81
Registering the Terminal ID	82
Managing the Address Book	84
Registering or modifying a Speed Dial number.....	84
Registering or modifying a Group Dial number.....	86
Registering or modifying a One Touch Dial key number	88
Setting SECURE RECEIVE	90

Operating the USER FUNCTIONS Menu

If you press [USER FUNCTIONS], you can specify default settings and make settings concerning the address book. Follow the procedure below to operate the USER FUNCTIONS menu.

Note

- Press [FUNCTION CLEAR] to cancel the menu operation while making settings.
- Press [CANCEL] to exit from the setting without making any changes. You can also exit with the ◀ button if it is enabled.
- When not all menu items can be displayed, a cursor icon is displayed. Press ▲ or ▼ to scroll menu.
- Press [CLEAR/STOP] to delete a character. Keep pressing [CLEAR/STOP] for a second to clear all characters.

1 Press [USER FUNCTIONS].

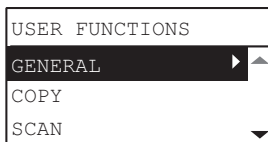
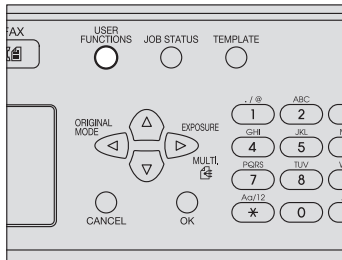

2 Press ▲ or ▼ to highlight the item to set.



3 Press ▶ to display the items in the lower hierarchies.

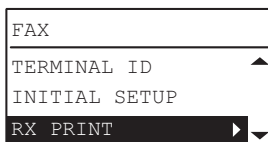

Repeat step 2 through 3 as many times as needed.

4 Press ▲ or ▼ to select the value to set.

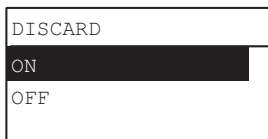

5 Press [OK] to confirm the set value.

■ Relationship between the digital keys and the input character

You can enter the characters displayed on the upper side of the digital keys.

Digital key	Number of times the key is pressed (→)									
1 ^{*1}	.	/	@	-	:	~	_	1		
2	A	B	C	2	a	b	c			
3	D	E	F	3	d	e	f			
4	G	H	I	4	g	h	i			
5	J	K	L	5	j	k	l			
6	M	N	O	6	m	n	o			
7	P	Q	R	S	7	p	q	r	s	
8	T	U	V	8	t	u	v			
9	W	X	Y	Z	9	w	x	y	z	
0	0									
# ^{*2}	<Space> - + ' [] \ ; , . / @ ~ ! # \$ % ^ & * () = _ { } < > : " ?									

*1 In some character input modes, you can only enter “.”, “/”, “@”, and “1”.

*2 In some character input modes (e.g., Scan to USB function), you can only enter Space, the minus (-) sign and the plus (+) sign.

User Functions Menu Items



The table below shows the functions and reference pages available in the “User Functions” menu.

■ User functions menu items

Menu Functions		Reference Pages	
FAX	TERMINAL ID	ID NAME	📖 P.78 “FAX”
		FAX NUMBER	
	INITIAL SETUP	RESOLUTION	
		ORIGINAL MODE	
		EXPOSURE	
		TTI	
		RTI	
		ECM	
		RX MODE	
		REMOTE RX	
		EASY MANUAL TX/RX	
		RINGER VOLUME	
		MONITOR VOLUME	
		COMPLETION VOLUME	
		DIAL TYPE	
		DOUBLE CHECK	
	TX END TONE		
	RX PRINT	FAX DRAWER SETTING	
		DISCARD	
REDUCTION			
SECURE RECEIVE			
REPORT SETTING	AUTO JOURNAL	📖 P.81 “REPORT SETTING”	
	MEMORY TX		
	MULTI TX		
LIST	ADDRESS BOOK	📖 P.81 “LIST”	
ADDRESS BOOK	E-MAIL*	-	
	PHONE BOOK	📖 P.81 “ADDRESS BOOK”	

* Not used in the fax function.

■ FAX

Menu Functions		Settings	Descriptions / Reference Pages
TERMINAL ID	ID NAME	-	 P.82 “Registering the Terminal ID”
	FAX NUMBER	-	
INITIAL SETUP	RESOLUTION	STANDARD, FINE, ULTRA FINE	Sets the resolution based on the fineness of the original. <div style="background-color: #cccccc; padding: 2px; display: inline-block;">Tip</div> If the recipient’s fax machine is not capable of receiving originals at the same resolution, the resolution is automatically converted before being sent to the recipient. The higher the resolution is, the longer it takes to send an original.
	ORIGINAL MODE	TEXT/PHOTO, TEXT, PHOTO	Sets the scanning mode based on the type of the original. <div style="background-color: #cccccc; padding: 2px; display: inline-block;">Tip</div> In the TEXT/PHOTO mode or PHOTO mode, the transmission time may be longer than in the TEXT mode.
	EXPOSURE	AUTO, MANUAL	Sets the density at which the original is to be scanned.
	FOG REDUCTION	ON, OFF	Sets the function for preventing the back side or a 2-sided original becoming visible on its front side.
	TTI	ON, OFF	Switch the TTI recording ON or OFF. To enable this feature, the Terminal ID must be registered to this equipment in advance.  P.82 “Registering the Terminal ID” <div style="background-color: #cccccc; padding: 2px; display: inline-block;">Tip</div> Setting this item may not be required since it may not be displayed on the screen (it depends on your country or region).
	RTI	ON, OFF	Switch the RTI recording ON or OFF. To enable this feature, the Terminal ID must be registered to this equipment in advance.  P.82 “Registering the Terminal ID”

Menu Functions		Settings	Descriptions / Reference Pages
INITIAL SETUP	ECM	ON, OFF	<p>Switch the ECM (Error Correction Mode) communication ON or OFF.</p> <p>ECM is an internationally standardized communication mode that automatically corrects errors that occur during fax transmissions. With this setting option ON, even when the transmitted data have been affected by noise during communication, this mode allows good communication without image distortion by automatically resending the parts that have been affected.</p> <p>Tip</p> <ul style="list-style-type: none"> • Both the sender and the receiver must have the ECM function to make ECM communication available. • When it is affected by noise during communication, the communication time is slightly longer than usual. Even when the ECM communication is used, an error may occur depending on the line status. • The ECM communication is not available for voice communication.
	RX MODE	AUTO, MANUAL	<p>Sets the default setting for the fax reception mode.</p> <p>Tip</p> <p>The following are required for manual reception.</p> <ul style="list-style-type: none"> • Installing an external telephone • Setting [REMOTE RX] to [DIAL] • Receiving the fax in manual reception or remote reception when you have an incoming call <p> P.38 “Manual reception”</p> <p> P.39 “Remote reception”</p>
	REMOTE RX	OFF, DIAL	<p>Sets the default setting for the remote fax reception mode.</p> <p>Tip</p> <p>When this is set to [DIAL], the equipment does not enter the energy saving mode (sleep mode) even if the [ENERGY SAVER] button is pressed. For details of the energy saving mode, refer to the User’s Guide.</p>
	EASY MANUAL TX/RX	EASY MODE, ADVANCED MODE	<p>Selects whether or not to display the TX/RX selection screen when you send/receive a fax manually while no original is placed on the RADF.</p>
	RINGER VOLUME	Manual	<p>Each volume can be set in 4 levels (0: tone Off).</p>

Menu Functions		Settings	Descriptions / Reference Pages	
INITIAL SETUP	MONITOR VOLUME	Manual	Monitor tone volume and Reception completion tone volume (You hear this tone when reception is completed). Each volume can be set in 4 levels (0: tone Off).	
	COMPLETION VOLUME	Manual		
	DIAL TYPE	DP, MF	When you first install this equipment or you change the connected telephone line, set this according to the telephone line type. Tip Setting this item may not be required since it may not be displayed on the screen (it depends on your country or region).	
	DOUBLE CHECK	-	-	Sets the function for preventing transmission to a wrong recipient.
		INPUT		Displays the screen for re-entering the recipient before transmission.
		CONFIRM		Displays the screen for confirming the recipient before transmission.
		OFF		Disables the function for preventing transmission to a wrong recipient.
TX END TONE	NORMAL END, ON ERROR, ALWAYS, OFF	Sets the notification function which sounds an alarm when the fax transmission is completed.		
RX PRINT	FAX DRAWER SETTING	OFF, DRAWER1, DRAWER2, DRAWER3, DRAWER4	Sets the fax-exclusive drawer for the fax reception.	
	DISCARD	ON	If an original is longer (up to 10 mm) than the printing area of the printing paper, the part that exceeds the paper printing area is discarded.	
		OFF	The printing discarding function is disabled.	
	REDUCTION	ON	If an original is longer (more than 10 mm (0.4 inch)) than the printing area, the original image is reduced by one size for printing.	
		OFF	The reduced printing function is disabled.	
SECURE RECEIVE	ENABLE, DISABLE	 P.90 "Setting SECURE RECEIVE"		

REPORT SETTING

Menu Functions		Settings	Descriptions / Reference Pages
AUTO JOURNAL		ON	When the number of transmissions and receptions reaches 60, the Transmission/Reception Journal is printed automatically.
		OFF	The Transmission/Reception Journal is not printed automatically.
MEMORY TX MULTI TX	OFF	-	Press this button to disable printing of communication report.
	ALWAYS	-	Press this button to always print the communication report.
	PRINT 1ST PAGE?	YES, NO	Select [YES] if you want to add the first page of the transmitted original to the communication report, and [No] if you do not want to add the first page.
	ON ERROR	-	Press this button to print the communication report in the event of an error.
	PRINT 1ST PAGE?	YES, NO	Select [YES] if you want to add the first page of the transmitted original to the communication report, and [No] if you do not want to add the first page.

LIST

Menu Functions	Settings	Descriptions / Reference Pages
ADDRESS BOOK	SPEED DIAL, GROUP DIAL, ONE TOUCH	Print the list of Speed Dial numbers, Group Dial numbers, and One Touch Dial key numbers that are registered in the Address Book.  P.47 "Dial list"

ADDRESS BOOK

Menu Functions	Settings	Descriptions / Reference Pages
PHONE BOOK	SPEED DIAL, GROUP DIAL, ONE TOUCH	Register or modify the Speed Dial numbers, Group Dial numbers, and One Touch Dial key numbers in the address book.  P.84 "Managing the Address Book"

Registering the Terminal ID

This section describes how to register the terminal ID of this equipment. If the terminal ID is registered in advance, sender information can be printed on the leading edge of the transmitted original, and receiver information on the trailing edge of the received fax.

1 From the USER FUNCTIONS menu, select [FAX] → [TERMINAL ID].

P.74 “Operating the USER FUNCTIONS Menu”

FAX
TERMINAL ID ▶ ▲
INITIAL SETUP
RX PRINT ▼

Press ▶ to start registering.

2 Press ▼ to select [ID NAME], and then press ▶.

TERMINAL ID
ID NAME ▶
FAX NUMBER

3 Enter the name (up to 20 characters) using the digital keys, and then press [OK].

P.75 “Character Entry”

ID NAME
MFP-A
:Aa

4 Press ▼ to select [FAX NUMBER] and then press ▶.

TERMINAL ID
ID NAME
FAX NUMBER ▶

5 Enter the telephone number (up to 20 characters) using the digital keys, and then press [OK].

FAX NUMBER
0123456789_
:12

Tip

The digital keys from 0 to 9 and # can be used to enter the telephone number. Spaces, “+” and “-” can be entered using #.

Example of how sender information is printed on paper

The sender information is printed at the top of the original.

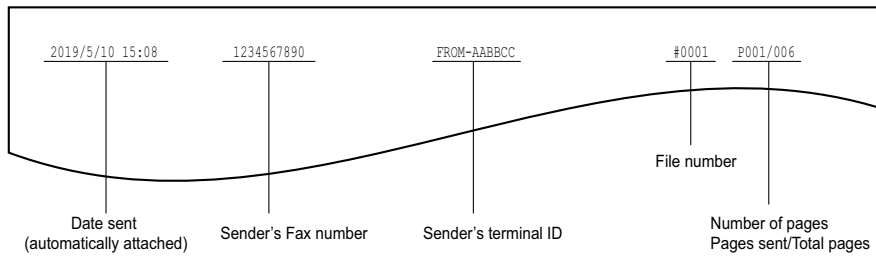

Example of how receiver information is printed on originals you receive

The recipient information is printed at the bottom of the original.

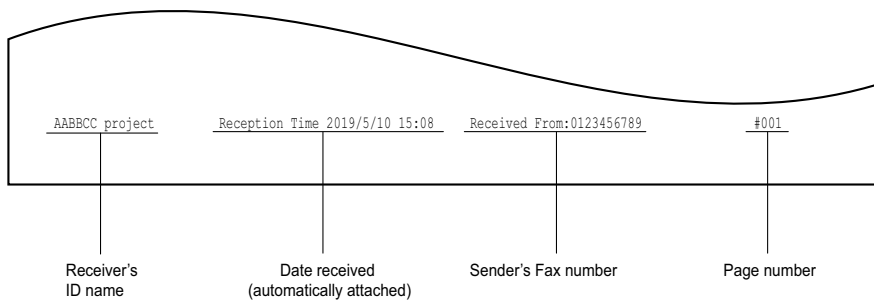

Managing the Address Book

Register the Speed Dial numbers, Group dial numbers, and One Touch Dial key numbers in the address book. The recipients registered in the address book are displayed as a list of recipients when [Address Book] is pressed. When sending a fax, you can select the list of recipients, and specify the transmission destination easily.

1 From the USER FUNCTIONS menu, select [ADDRESS BOOK] → [PHONE BOOK], and then press ▷.

P.74 “Operating the USER FUNCTIONS Menu”

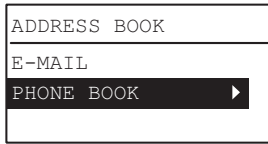

2 Select any one of the following using △ or ▽ :

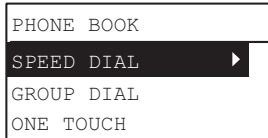

Item name	Description	Reference Pages
SPEED DIAL	Registers or modifies a speed dial number.	P.84 “Registering or modifying a Speed Dial number”
GROUP DIAL	Registers or modifies a group dial number.	P.86 “Registering or modifying a Group Dial number”
ONE TOUCH	Registers or modifies a one touch dial number.	P.88 “Registering or modifying a One Touch Dial key number”

3 Press ▷ to start registering.

■ Registering or modifying a Speed Dial number

You can register a combined total of 200 Speed Dial numbers between telephone numbers and e-mail addresses. This information is stored into Speed Dial numbers labeled from 001 to 200.

Tip

- You can also register Speed Dial numbers by using the Web-based utility TopAccess. For details, see the *TopAccess Guide*.
- Confirm the registered contents on the Speed Dial number List.
 P.51 “Speed Dial number list”

1 Enter the Speed Dial number (1 to 200) using the digital keys, and then press [OK].

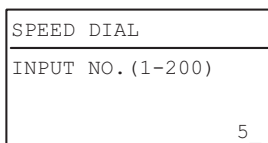

Tip

Entering an already registered speed dial number displays a screen indicating the number is registered.

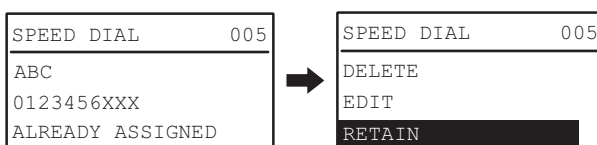

- To delete a registered Speed Dial number, press △ or ▽ to select [DELETE], and then press [OK].
- To edit a registered Speed Dial number, press △ or ▽ to select [EDIT], and then press ▷ to proceed to the next step.
- To leave the registered Speed Dial number unchanged, select [RETAIN], and then press [OK] or [CANCEL].

2 Press Δ or ∇ to select [NAME], and then press \triangleright .

SPEED DIAL	005
COMPLETE	
NAME	\triangleright
FAX NUMBER	

3 Enter the name (up to 20 characters) using the digital keys, and then press [OK].

 P.75 “Character Entry”

SPEED DIAL	005
ENTER NAME (MAX20)	
XX company_	
 :Aa	

4 Press Δ or ∇ to select [FAX NUMBER], and then press \triangleright .

SPEED DIAL	005
COMPLETE	
NAME	
FAX NUMBER	\triangleright

5 Enter the telephone number (up to 21 digits) using the digital keys, and then press [OK].

SPEED DIAL	005
INPUT FAX NUMBER	
01234XXXX_	
 :12	

The pause necessary when dialing to an outside line via a PBX (0+ dialing, for example) or transmitting a fax to an overseas destination can be inserted by pressing [PAUSE] where required. One [PAUSE] inserts a pause of approximately 2 seconds.

6 Press Δ or ∇ to select [COMPLETE], and then press [OK].

SPEED DIAL	005
COMPLETE	
NAME	
FAX NUMBER	

7 After displaying the completion screen, the screen returns to that for registering the Speed Dial number.

SPEED DIAL	005
XX company	
01234XXXX	
COMPLETED	

■ Registering or modifying a Group Dial number

Register the recipients to whom an original is to be sent at once as a group.

- Specify the recipients to be registered in the group from among those registered under speed dial and one touch dial.
- You can specify a maximum of 50 recipients.
- You can register up to 20 groups.

Tip

- You can also register the Group Dial Numbers by using the Web-based utility TopAccess. For details, see the **TopAccess Guide**.
- Confirm the registered contents on the Speed Dial number list, One Touch dial list, and Group Number list.
 P.51 “Group Dial number list”

1 Enter the Group Dial number (1 to 20) using the digital keys, and then press [OK].

GROUP DIAL	
INPUT NO. (01-20)	
	8

Tip

Entering an already registered Group Dial number displays a screen indicating the number is registered.

GROUP DIAL	08
AABBCC	
ZZZ Inc.	
ALREADY ASSIGNED	

 →

GROUP DIAL	08
DELETE	
EDIT	
RETAIN	

- To delete a registered Group Dial number, press Δ or ∇ to select [DELETE], and then press [OK].
- To edit a registered Group Dial number, press Δ or ∇ to select [EDIT], and then press \triangleright to proceed to the next step.
- To leave the registered Group Dial number unchanged, select [RETAIN], and then press [OK] or [CANCEL].

2 Press Δ or ∇ to select [NAME], and then press \triangleright .

GROUP DIAL	08
COMPLETE	
NAME	\triangleright
FAX NUMBER	

3 Enter the name (up to 20 characters) using the digital keys, and then press [OK].

 P.75 “Character Entry”

GROUP DIAL	08
ENTER NAME (MAX20)	
Group B2	
 :Aa	

4 Press Δ or ∇ to select [FAX NUMBER], and then press \triangleright .

GROUP DIAL	08
COMPLETE	
NAME	
FAX NUMBER	\triangleright

5 Specify the number (Speed Dial number or One Touch Dial key) which is added to a group.

GROUP DIAL	08
ENTER SPEED NO. OR ONE TOUCH KEY	

- Using a Speed Dial number:
Enter the desired number and then press [OK].
- Using One Touch Dial key:
Press the desired key.

Tip

When the specified Speed Dial number or One Touch Dial key number is not registered, a screen indicating the number is unregistered is displayed.

GROUP DIAL	08
SPEED DIAL	:001
NUMBER NOT LISTED	

6 To add the next number, select [ADD] using \triangle or ∇ , and then press \triangleright .

GROUP DIAL	08
ADD	\triangleright
REVIEW LIST	
COMPLETE	

Repeat steps 5 and 6 as many times as needed.

Tip

To confirm/delete a recipient registered in the Group Dial number, press \triangle or ∇ to select [REVIEW LIST], and then press \triangleright .

- To confirm a recipient registered in the group
After specifying the recipient, select [CHECK] and press \triangleright .

GROUP DIAL	08
ADD	
REVIEW LIST	\triangleright
COMPLETE	

 \triangleright

GROUP DIAL	08
AAA	
ABC Co.Ltd	
Tokyo Inc.	\triangleright

 \triangleright

GROUP DIAL	08
CHECK	\triangleright
DELETE	

 \triangleright

GROUP DIAL	08
SPEED NO.	:001
Tokyo Inc.	
022333XXX	

- To remove a recipient registered in the group
After specifying the recipient, select [DELETE] and press [OK].
Press [OK] on the confirmation screen.

GROUP DIAL	08
ADD	
REVIEW LIST	\triangleright
COMPLETE	

 \triangleright

GROUP DIAL	08
AAA	
ABC Co.Ltd	
Tokyo Inc.	\triangleright

 \triangleright

GROUP DIAL	08
CHECK	
DELETE	\triangleright

 \triangleright

ARE YOU SURE?	
YES	\triangleright
NO	

7 When all the numbers are entered, select [COMPLETE] using \triangle or ∇ , and then press [OK].

GROUP DIAL	08
ADD	
REVIEW LIST	
COMPLETE	\triangleright

8 Press [OK] on the confirmation screen that displays.

GROUP DIAL	08
COMPLETE	
NAME	
FAX NUMBER	

9 After displaying the completion screen, the screen returns to that for registering the Group Dial number.

GROUP DIAL	08
Group B2	
COMPLETED	

■ Registering or modifying a One Touch Dial key number

You can register up to five telephone numbers for One Touch dialing.

Tip

- You can also register the One Touch Dial key numbers by using the Web-based utility TopAccess. For details, see the **TopAccess Guide**.
- Confirm the registered contents on the One Touch Dial numbers list.
📖 P.52 “One Touch Dial key list”

1 Enter the One Touch Dial key number (1 to 5) using the digital keys, and then press [OK].

ONE TOUCH	
INPUT NO. (1-5)	
	2

Tip

Entering an already registered number of One Touch Dial key number displays a screen indicating the number is registered.

ONE TOUCH	2
4F-MFP	
012345XXXX	
ALREADY ASSIGNED	

 →

ONE TOUCH	2
DELETE	
EDIT	
RETAIN	

- To delete a registered number of One Touch Dial key number, press Δ or ∇ to select [DELETE], and then press [OK].
- To edit a registered number of One Touch dial key, press Δ or ∇ to select [EDIT], and then press \triangleright to proceed to the next step.
- To leave the registered number of One Touch Dial key number unchanged, select [RETAIN], and then press [OK] or [Cancel].

2 Press Δ or ∇ to select [NAME], and then press \triangleright .

ONE TOUCH	2
COMPLETE	
NAME	
FAX NUMBER	

3 Enter the name (up to 20 characters) using the digital keys, and then press [OK].

 P.75 “Character Entry”

ONE TOUCH	2
ENTER NAME (MAX20)	
4F-MFP_	
☐☐ :Aa	

4 Press \triangle or ∇ to select [FAX NUMBER], and then press \triangleright .

ONE TOUCH	2
COMPLETE	
NAME	
FAX NUMBER \triangleright	

5 Enter the telephone number (up to 50 digits) using the digital keys, and then press [OK].

ONE TOUCH	2
INPUT FAX NUMBER	
0123444XX_	
☐☐ :12	

The pause necessary when dialing to an outside line via a PBX (0+ dialing, for example) or transmitting a fax to an overseas destination can be inserted by pressing [PAUSE] where required. One [PAUSE] inserts a pause of approximately 2 seconds.

6 Press \triangle or ∇ to select [COMPLETE], and then press [OK].

ONE TOUCH	2
COMPLETE	
NAME	
FAX NUMBER	

7 After displaying the completion screen, the screen returns to that for registering the One Touch Dial key number.

ONE TOUCH	2
4F-MFP	
0123444XX	
COMPLETED	

Setting SECURE RECEIVE

The SECURE RECEIVE function allows you to store received fax jobs in the equipment without printing them. With this function, you can prevent the leaking of confidential information in a fax received when no people are present in your office, such as nighttime or holidays, or when an unspecified number of people visit your office. The SECURE RECEIVE function can be manually enabled/disabled, or automatically enabled/disabled at a specified time and day.

1 From the USER FUNCTIONS menu, select [FAX] → [RX PRINT].

P.74 “Operating the USER FUNCTIONS Menu”

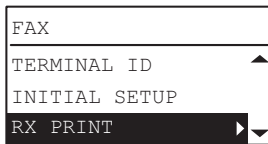

2 Press ▽ to select [SECURE RECEIVE], and then press ▷.

P.74 “Operating the USER FUNCTIONS Menu”

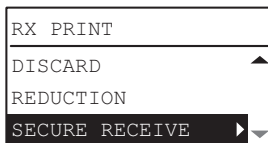

3 Select [ENABLE], and then press ▷.

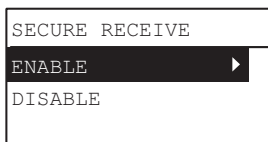

4 Set the Password, Time, and Day.

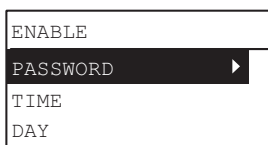

Item name	Settings
PASSWORD	You can set a password for printing a received SECURE RECEIVE fax. Enter a four digit number (0000-9999).
TIME	You can set the time for automatically enabling the SECURE RECEIVE function. <ul style="list-style-type: none"> Time is displayed in 24-hour format. To disable printing of SECURE RECEIVE faxes throughout the day, set [ON TIME]/[OFF TIME] to blank. Setting the same time in [ON TIME]/[OFF TIME] prints the SECURE RECEIVE faxes at the set time. To clear the entered time, press [CLEAR/STOP].
DAY	Select [SETTING] or [ALL DAY] for each day of the week. Selecting [SETTING] enables the SECURE RECEIVE function at the time set in [TIME].

5 Press [OK].

TROUBLESHOOTING AND SPECIFICATIONS

This chapter describes troubleshooting and specifications of Fax.

Troubleshooting	92
Error messages.....	92
Transmission/reception trouble	93
Specifications of Fax	95

Troubleshooting

■ Error messages

When the following messages appear on the LCD screen, press the [FUNCTION CLEAR] button to clear the error message and perform the appropriate remedy for the error.

If you encounter an error code not listed here, see the *User's Guide*.

⚠ WARNING

Never attempt to repair, disassemble or modify the equipment by yourself.

You could cause a fire or get an electric shock. Always contact your service representative for maintenance or repair of the internal parts of the equipment.

Note

When the message "MISFEED Exxx" or "ADD PAPER" is displayed, memory reception may be performed. Clear the message without turning off the power.

Message	Cause	Remedy
MISFEED Exxx	Original or paper misfeed.	An error code "xxx" and a message for solving the problem are displayed. Remove any misfed original or paper.
MEMORY IS FULL	The memory became full during data entry into memory during a transmission.	Press any key to restore the idle state. Memory full during TX: Wait for the memory to become available and then retry memory transmission, or perform direct transmission. Memory full during RX: Contact the other party to re-transmit the document.
COUNT OVER	The number of pages scanned has exceeded the maximum value (50 sheets).	CANCEL JOB: The scanned jobs are canceled. SEND: Scanning is stopped and the scanned images already stored in the memory will be sent.
PUT DOCUMENT FEEDER DOWN	The RADF or its cover has been left open after placing the originals.	Close the RADF, or the cover.
DRAWER # EMPTY ADD PAPER	Paper has run out in the designated drawer, or the drawer is removed. "ADD PAPER" is displayed when [FAX DRAWER SETTING = OFF] and all paper source is empty.	Load recording paper, or insert the drawer firmly. Memory reception may be performed. Do not turn off the power.
LOAD XX (Only for e-STUDIO2829A Series)	There is no appropriate paper for the received original.	Change the paper size setup to match the request.
HUNG UP THE PHONE	The external telephone is busy for a long time.	Hang up the external phone.
ERROR:CHECK COPY MODE	An error such as misfeed or toner empty has occurred.	Press [COPY], to confirm the error. For details, refer to the <i>User's Guide</i> .
FAX ERROR xxxx	A communication error occurred during transmission/reception.	Send or receive again.
PUT ORIGINAL ON GLASS.	Original detected in RADF feed tray when "NEXT ORIGINAL?" was displayed.	Remove original from RADF feed tray.

Primary fax error codes

0071	The memory is full (during reception).
00AB	The line is busy.
00AD	The dialed number is not for fax.
00D7	The number of redial times has exceeded the specified one.
00FE	The memory is full (during transmission).

■ Transmission/reception trouble

Below is a list of trouble you might encounter during the transmission/reception.

Transmission troubles

Trouble	Check Point
TRANSMIT is not displayed even if the [START] button is pressed.	<ul style="list-style-type: none"> • Is the modular cord disconnected? • Is the LINE type correctly set? • Can you receive telephone calls? • Is there any problem at the recipient's Fax? Check this with the party trying to receive the original.
Originals are fed diagonally.	<ul style="list-style-type: none"> • Are the document feeder slides adjusted to the width of the original that you are sending? • Does the original that you are sending match the conditions of transmittable original?
2 originals are fed together.	<ul style="list-style-type: none"> • Have you placed more than the maximum number of originals that can be placed at one time (50 sheets for 50 to 104 g/m² or 9.5 mm or less stack height)? • Does the original that you are sending match the conditions of the original that is available for sending? • Have you pushed the originals into the feeder too hard?
The original is not being printed on the paper of the recipient's Fax even though it has been sent.	Was the original placed correctly facing up? When placing the original on the original glass, specify the original size.
Black lines are shown in the image that was sent.	Is the scanning area of the Reversing Automatic Document Feeder clean? Clean it with a soft cloth.
Originals are not sent even if operations are carried out normally.	Is the recipient's Fax compatible with your system? This system supports G3 communications but not G2 or G4 communications.
Originals cannot be sent overseas.	Specify Quality TX and resend.  P.26 "Setting the transmission conditions"

Reception troubles

Trouble	Check Point
Originals cannot be received even if the [START] button is pressed.	<ul style="list-style-type: none">• Is the modular cord disconnected?• Is there a problem at the sender's Fax? Check this with the party trying to send the original.
Paper is not output.	Is the equipment out of paper?
The received original is printed dark and is illegible or black stripes are printed on the original.	<ul style="list-style-type: none">• Make a local copy and confirm proper printing.• Is the original being sent a dirty copy? Check this with the party trying to send the original.• Is the trouble due to a problem or operation error at the sender's Fax? Check this with the party trying to send the original.
Paper is output but not printed.	<ul style="list-style-type: none">• Is there enough toner?• Is the original placed correctly on the sender's Fax? Check this with the party trying to send the original.
Paper often misfeeds.	<ul style="list-style-type: none">• Is the paper drawer size setting correct?• Is the paper drawer properly inserted?• Is the specified paper type being used?

Tip

If the suggested action does not solve the trouble or you encounter trouble not listed above, contact your service technician or service representative.

Specifications of Fax

Model Name	GD-1380 / DP-2822AF
Size of Original	A/B format: A3 ^{*1} , A4, A4-R ^{*1} , A5-R, B4 ^{*1} , B5, B5-R ^{*1} , FOLIO ^{*2} LT format: LD ^{*1} , LG ^{*1} , LT, LT-R ^{*1} , ST-R, COMP ^{*1} K format: 8K ^{*1} , 16K, 16K-R
Recording Paper Size	A/B format: A3 ^{*2} , A4, A4-R ^{*2} , A5-R ^{*2} , B4 ^{*2} , B5 ^{*2} , B5-R ^{*2} , FOLIO ^{*2} LT format: LD ^{*2} , LG ^{*2} , LT, LT-R ^{*2} , ST-R ^{*2} , COMP ^{*2} K format: 8K, 16K ^{*2} , 16K-R ^{*2}
Compatibility Communication Modes	ECM, G3 (Super G3)
Communication Resolution	Horizontal: 8 dots/mm, 16 dots/mm, 300 dots/inch Vertical: 3.85 lines/mm, 7.7 lines/mm, 15.4 lines/mm, 300 dots/inch
Transmission Rate	33,600/31,200/28,800/26,400/24,000/21,600/19,200/16,800/14,400/ 12,000/9,600/7,200/4,800/2,400 bps
Encoding Systems	JBIG/MMR/MR/MH
Memory Capacity	6 MB
Unit Type	Desktop type, transmitting/receiving dual type
Applicable Network	Public Switched Telephone Network (PSTN)

*1 With e-STUDIO2822AF, originals of this size can be scanned only by using the RADF.

*2 Only for e-STUDIO2829A Series.

The battery life is approximately 5 years for 8 hours of operation per day. If the battery is run down, ask your service technician. (Repair and replacement will be charged.)

* Specifications and appearance are subject to change without notice in the interest of product improvement.

* If trouble occurs, call service for assistance.

INDEX

A			
About	63		
address book.....	59		
Address Book box.....	60		
[ADDRESS BOOK] button	14		
Alarm lamp	15		
AUTO JOURNAL.....	81		
C			
[CANCEL] button	15		
Change Name	70		
Checking reception status (log)	39		
[CLEAR/STOP] button	15		
Connecting cables.....	17		
Contact list	60		
Control panel.....	14		
Cover Sheet box	62		
Cover Sheet Information	62		
cover sheet properties	61		
D			
date and time	16		
Date/Time.....	61		
Delete.....	68, 71		
Delete from List.....	60		
Department Code.....	63		
Destination List	61		
Dial list.....	47		
Digital keys	15		
E			
ECM	28		
Edit Address Book	60, 63		
[ENERGY SAVER] button.....	15		
Error messages.....	92		
EXPOSURE	26		
Exposure	16		
External telephone.....	17		
F			
FAX	77		
[FAX] button	14		
fax driver options	63		
Fax Number field	60		
Fax screen.....	16		
Faxing	55		
Features and Functions	54		
Format box	60		
[FUNCTION CLEAR] button	15		
G			
Group Name	70		
J			
[JOB STATUS] button.....	14		
Journal	46		
L			
LCD screen.....	15		
List of Destination	60		
M			
Message	16		
		MIXED SIZE ORIGINAL..... 28	
		[MONITOR] button..... 14	
N			
		network fax options	59
		New	69
		Next original	21
O			
		[OK] button	15
		One Touch Dial keys	15
		Open.....	60
		Orientation	63
		Original	
		original scanning range	26
		originals that can be sent	25
		placing the original(s) on the RADF.....	24
		placing the original(s)	
		on the original glass.....	23
		ORIGINAL MODE.....	27
		Original mode.....	16
		ORIGINAL SIZE	27
P			
		Paper	
		acceptable size of paper	40
		default setting for RX printing	40
		paper priority when there is	
		no same size paper	40
		Paper Size	63
		[PAUSE] button.....	14
		PRINT DATA lamp	15
		Printing list & report	
		samples	50
		Printing lists & reports	
		automatically	49
		manually.....	46
Q			
		QUALITY TX	27
R			
		RADF (Reversing Automatic	
		Document Feeder)	20, 24
		Receiver information.....	82, 83
		Receiving	
		AUTO reception.....	38
		Forwarding received faxes	39
		Manual reception	38
		Memory reception.....	38
		Remote reception	39
		Recipient	
		direct entry with digital keys	28
		group entry.....	33
		multi	30
		one touch key dialing.....	29
		searching the recipient	
		in the address book	31
		specifying the recipient	
		in the address book	31
		speed dial	32
		Redial function	21

Remaining memory	16
Reservation list.....	47
RESOLUTION	27
Resolution	63
[RESOLUTION] button	14
Restore.....	64

S

Same width originals	24
Scroll icon.....	16
Select cover sheet	61
Sender Information.....	61
Sender information.....	61, 62, 82, 83
Set as Destination	60
SINGLE/2-SIDED_SCAN	27
SNMP settings	63, 64
Specifications.....	95
Specifying recipients.....	57
[START] button.....	15

T

Telephone line	17
TERMINAL ID.....	77, 78
Terminal ID	82
transmission and reception journal.....	46
Transmission conditions	
making settings	26
Trouble	93

U

[UP/DOWN/LEFT/RIGHT] buttons	15
[USER FUNCTIONS] button.....	14

W

With a Message.....	61, 62
---------------------	--------

MULTIFUNCTIONAL DIGITAL SYSTEMS

Fax Guide

e-STUDIO2822AF

e-STUDIO2329A/2829A
(with GD-1380)

Toshiba Tec Corporation

1-11-1, OSAKI, SHINAGAWA-KU, TOKYO, 141-8562, JAPAN

©2019 Toshiba Tec Corporation All rights reserved
Patent; <http://www.toshibatec.com/en/patent/>



R180420U7900-TTEC
Ver00 F1 Issued in May 2019